

JVC



COMPACT COMPONENT SYSTEM

MX-GT700 — Consists of CA-MXGT700 and SP-MXGT700.

MX-G500 — Consists of CA-MXG500 and SP-MXG500.

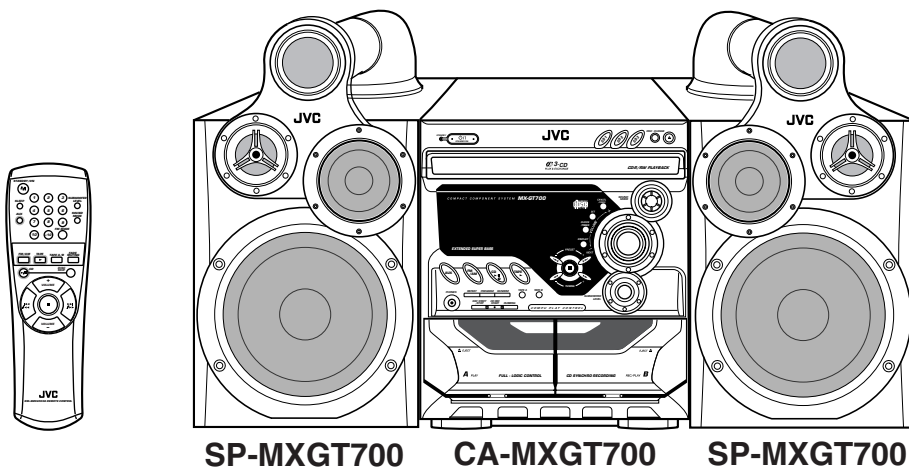

COMPACT
disc
DIGITAL AUDIO

SP-MXGT700 CA-MXGT700 SP-MXGT700

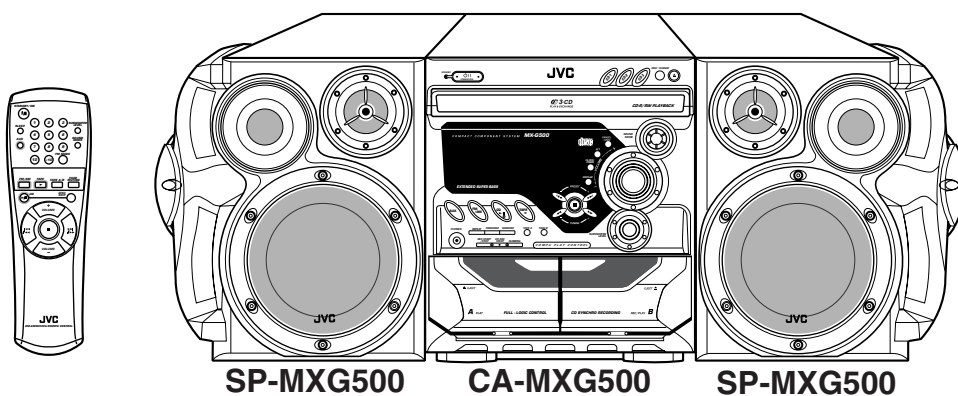

COMPACT
disc
DIGITAL AUDIO

SP-MXG500 CA-MXG500 SP-MXG500

INSTRUCTIONS

For Customer Use:

Enter below the Model No. and Serial No. which are located either on the rear, bottom or side of the cabinet. Retain this information for future reference.

Model No. _____

Serial No. _____

LVT0901-001A

[J]

Warnings, Cautions and Others

Mises en garde, précautions et indications diverses

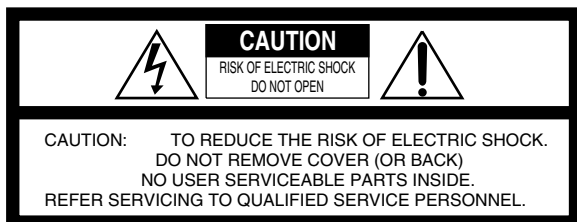

The lightning flash with arrowhead symbol, within an equilateral triangle is intended to alert the user to the presence of uninsulated "dangerous voltage" within the product's enclosure that may be of sufficient magnitude to constitute a risk of electric shock to persons.



The exclamation point within an equilateral triangle is intended to alert the user to the presence of important operating and maintenance (servicing) instructions in the literature accompanying the appliance.

For U.S.A.

This equipment has been tested and found to comply with the limits for a Class B digital device, pursuant to part 15 of the FCC Rules. These limits are designed to provide reasonable protection against harmful interference in a residential installation.

This equipment generates, uses and can radiate radio frequency energy and, if not installed and used in accordance with the instructions, may cause harmful interference to radio communications. However, there is no guarantee that interference will not occur in a particular installation. If this equipment does cause harmful interference to radio or television reception, which can be determined by turning the equipment off and on, the user is encouraged to try to correct the interference by one or more of the following measures:

Reorient or relocate the receiving antenna.
Increase the separation between the equipment and receiver.
Connect the equipment into an outlet on a circuit different from that to which the receiver is connected.
Consult the dealer or an experienced radio/TV technician for help.

WARNING: TO REDUCE THE RISK OF FIRE OR ELECTRIC SHOCK, DO NOT EXPOSE THIS APPLIANCE TO RAIN OR MOISTURE.

CAUTION

To reduce the risk of electrical shocks, fire, etc.:

1. Do not remove screws, covers or cabinet.
2. Do not expose this appliance to rain or moisture.

ATTENTION

Afin d'éviter tout risque d'électrocution, d'incendie, etc.:

1. Ne pas enlever les vis ni les panneaux et ne pas ouvrir le coffret de l'appareil.
2. Ne pas exposer l'appareil à la pluie ni à l'humidité.

Caution — STANDBY/ON switch!

Disconnect the mains plug to shut the power off completely. The  STANDBY/ON switch in any position does not disconnect the mains line. The power can be remote controlled.

Attention — Commutateur STANDBY/ON!

Déconnecter la fiche de secteur pour couper complètement le courant. Le commutateur  STANDBY/ON ne coupe jamais complètement la ligne de secteur, quelle que soit sa position. Le courant peut être télécommandé.

1. CLASS 1 LASER PRODUCT
2. **DANGER:** Invisible laser radiation when open and interlock failed or defeated. Avoid direct exposure to beam.
3. **CAUTION:** Do not open the top cover. There are no user serviceable parts inside the Unit; leave all servicing to qualified service personnel.

1. PRODUIT LASER CLASSE 1
2. **ATTENTION:** Radiation laser invisible quand l'appareil est ouvert ou que le verrouillage est en panne ou désactivé. Éviter une exposition directe au rayon.
3. **ATTENTION:** Ne pas ouvrir le couvercle du dessus. Il n'y a aucune pièce utilisable à l'intérieur. Laisser à un personnel qualifié le soin de réparer votre appareil.

For Canada/pour le Canada

CAUTION: TO PREVENT ELECTRIC SHOCK, MATCH WIDE BLADE OF PLUG TO WIDE SLOT, FULLY INSERT.

ATTENTION: POUR EVITER LES CHOCS ELECTRIQUES, INTRODUIRE LA LAME LA PLUS LARGE DE LA FICHE DANS LA BORNE CORRESPONDANTE DE LA PRISE ET POUSSER JUSQU'AU FOND.

For Canada/pour le Canada

THIS DIGITAL APPARATUS DOES NOT EXCEED THE CLASS B LIMITS FOR RADIO NOISE EMISSIONS FROM DIGITAL APPARATUS AS SET OUT IN THE INTERFERENCE-CAUSING EQUIPMENT STANDARD ENTITLED "DIGITAL APPARATUS," ICES-003 OF THE DEPARTMENT OF COMMUNICATIONS.

CET APPAREIL NUMERIQUE RESPECTE LES LIMITES DE BRUITS RADIOELECTRIQUES APPLICABLES AUX APPAREILS NUMIRIQUES DE CLASSE B PRESCRITES DANS LA NORME SUR LE MATERIEL BROUILLEUR: "APPAREILS NUMERIQUES", NMB-003 EDICTEE PAR LE MINISTRE DES COMMUNICATIONS.

Introduction

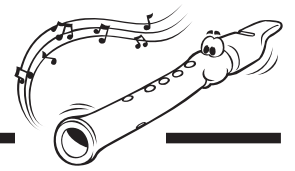

We would like to thank you for purchasing one of our JVC products. Before operating this unit, read this manual carefully and thoroughly to obtain the best possible performance from your unit, and retain this manual for future reference.

About This Manual

This manual is organized as follows:

- The manual mainly explains operations using the buttons and controls on the unit. You can also use the buttons on the remote control if they have the same or similar names (or marks) as those on the unit. If operation using the remote control is different from that using the unit, it is then explained.
- Basic and common information that is the same for many functions is grouped in one place, and is not repeated in each procedure. For instance, we do not repeat the information about turning on/off the unit, setting the volume, changing the sound effects, and others, which are explained in the section “Common Operations” on pages 9 and 10.
- The following marks are used in this manual:



Gives you warnings and cautions to prevent damage or risk of fire/electric shock. Also gives you information which is not good for obtaining the best possible performance from the unit.



Gives you information and hints you had better know.

Precautions

Installation

- Install in a place which is level, dry and neither too hot nor too cold—between 5°C (41°F) and 35°C (95°F).
- Install the unit in a location with adequate ventilation to prevent internal heat built-up in the unit.
- Leave sufficient distance between the unit and the TV.
- Keep the speakers away from the TV to avoid interference with TV.



DO NOT install the unit in a location near heat sources, or in a place subject to direct sunlight, excessive dust or vibration.

Power sources

- When unplugging from the wall outlet, always pull the plug, not the AC power cord.



DO NOT handle the AC power cord with wet hands.

Moisture condensation

Moisture may condense on the lens inside the unit in the following cases:

- After starting heating in the room
 - In a damp room
 - If the unit is brought directly from a cold to a warm place
- Should this occur, the unit may malfunction. In this case, leave the unit turned on for a few hours until the moisture evaporates, unplug the AC power cord, and then plug it in again.

Others

- Should any metallic object or liquid fall into the unit, unplug the unit and consult your dealer before operating any further.
- If you are not going to operate the unit for an extended period of time, unplug the AC power cord from the wall outlet.



DO NOT disassemble the unit since there are no user serviceable parts inside.

If anything goes wrong, unplug the AC power cord and consult your dealer.

Contents

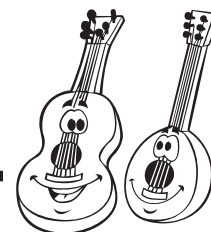

Location of the Buttons and Controls	3
Front Panel	3
Remote Control	5
Getting Started	6
Unpacking	6
Putting the Batteries into the Remote Control	6
Connecting Antennas	6
Connecting Speakers	7
Connecting Other Equipment	8
Canceling the Display Demonstration	8
Common Operations	9
Turning On or Off the Power	9
Setting the Clock	9
Selecting the Sources	9
Adjusting the Volume	10
Reinforcing the Bass Sound	10
Selecting the Sound Modes	10
Listening to the Radio	11
Tuning in a Station	11
Presetting Stations	11
Tuning in a Preset Station	11
Playing Back CDs	12
Loading CDs	12
Playing Back CDs—All Disc and One Disc	12
Basic CD Operations	13
Programming the Playing Order of the Tracks	
—Program Play	14
Playing at Random—Random Play	15
Repeating Tracks or CDs—Repeat Play	15
Prohibiting Disc Ejection—Tray Lock	15
Playing Back Tapes	16
Playing Back a Tape	16
Recording	17
Recording a Tape on Deck B	17
Dubbing Tapes	18
CD Synchronized Recording	18
Using the Timers	19
Using Daily Timer	19
Using Recording Timer	20
Using Sleep Timer	21
Timer Priority	21
Maintenance	22
Troubleshooting	23
Specifications	24

Location of the Buttons and Controls

Become familiar with the buttons and controls on your unit.

Front Panel

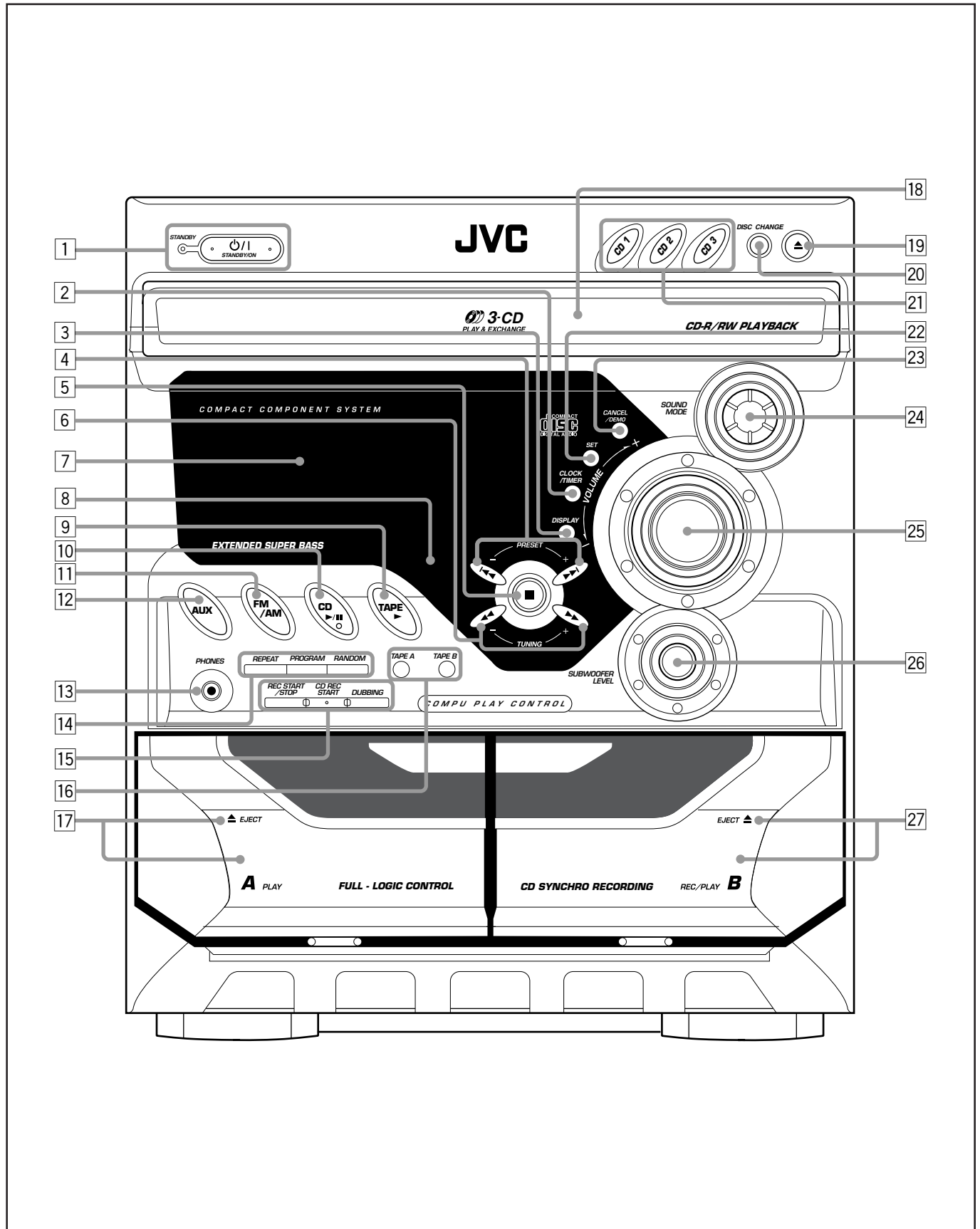

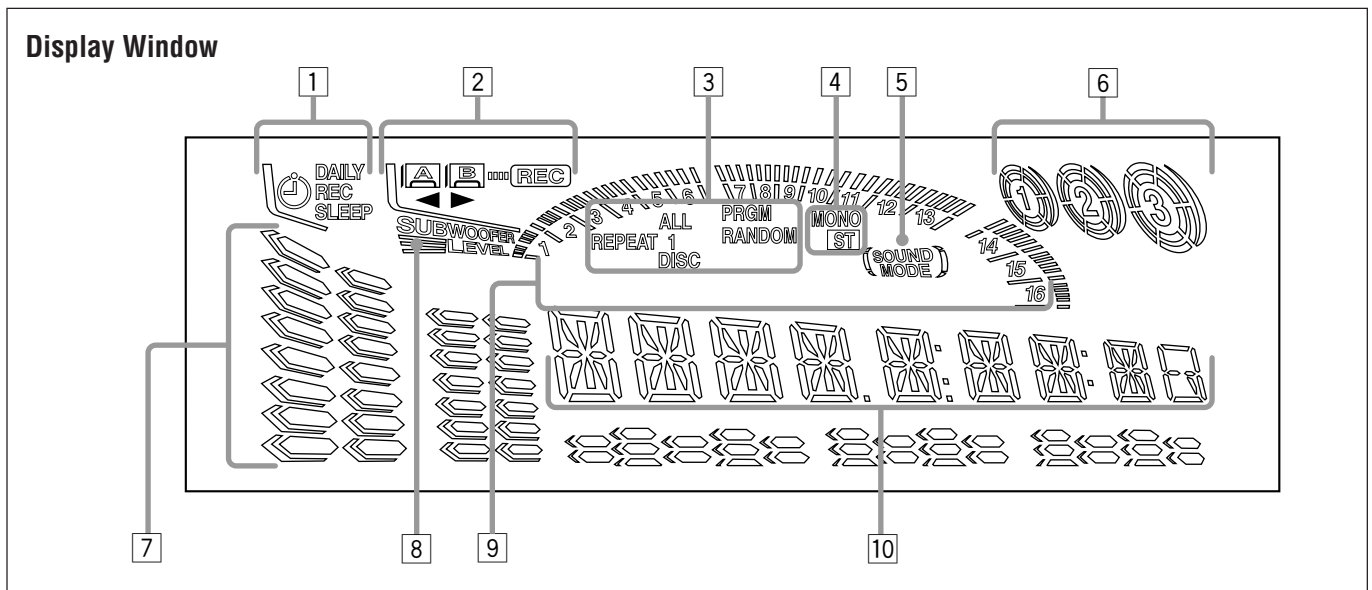

See pages in the parentheses for details.

Front Panel

- 1 **⏻/I** STANDBY/ON button and STANDBY lamp (9)
- 2 **CLOCK/TIMER** button (9, 19 – 21)
- 3 **DISPLAY** button (9)
- 4 **PRESET +/-** buttons (11)
◀◀ / ▶▶ (reverse search/forward search) buttons (9, 13 – 15, 19 – 21)
- 5 **■** (stop) button (12 – 18)
- 6 **TUNING +/-** buttons (11)
◀◀ / ▶▶ (fast forward/fast rewind) buttons (13, 16)
- 7 Display window
- 8 Remote sensor
- 9 **TAPE ▶** button and lamp (9, 16, 18)
Pressing this button also turns on the unit.
- 10 **CD ▶/||** (play/pause) button and lamp (9, 12 – 15)
Pressing this button also turns on the unit.
- 11 **FM/AM** button and lamp (9, 11)
Pressing this button also turns on the unit.
- 12 **AUX** button and lamp (9)
Pressing this button also turns on the unit.
- 13 **PHONES** jack (10)
- 14 **REPEAT** button (12, 13, 15)
PROGRAM button (14)
RANDOM button (15)
- 15 **REC START/STOP** button (17)
CD REC START button (18)
DUBBING button (18)
- 16 **TAPE A** button (16)
TAPE B button (16)
- 17 **Deck A** cassette holder (16, 18)
Pressing the ▲ EJECT portion opens the holder.
- 18 Carrousel
- 19 **▲** (Carrousel open/close) button (12, 13 – 15)
Pressing this button also turns on the unit.
- 20 **DISC CHANGE** button (12, 13)

- 21 **Disc number** buttons and lamps (CD1, CD2, and CD3) (13 – 15, 18)

Pressing one of these buttons also turns on the unit.

- 22 **SET** button (9, 11, 14, 19 – 21)
- 23 **CANCEL/DEMO** button (8, 9, 14, 20, 21)
- 24 **SOUND MODE** control (10)
- 25 **VOLUME** control (10)
- 26 **SUBWOOFER LEVEL** control (10)
- 27 **Deck B** cassette holder (16 – 18)

Pressing the EJECT ▲ portion opens the holder.

Display window

- 1 **Timer** indicators
 - **DAILY** (daily timer), **REC** (recording timer), **SLEEP** (sleep timer), and **⌚** (timer) indicators
- 2 **Tape operation** indicators
 - **A/B** (operating deck), **REC** (recording), and **◀▶** (tape running) indicators
- 3 **CD play mode** indicators
 - **REPEAT** (1, 1 DISC, ALL DISC), **PRGM** (program), and **RANDOM** indicators
- 4 **Tuner operation** indicators
 - **MONO** and **ST** (stereo) indicators
- 5 **SOUND MODE** indicator
- 6 **Disc** indicators
- 7 **Volume level, Subwoofer level and Sound Mode** pattern indicators
- 8 **SUBWOOFER LEVEL** indicator
- 9 **CD track number** indicators
- 10 **Main display**
 - Shows the source name, frequency, etc.



Remote Control

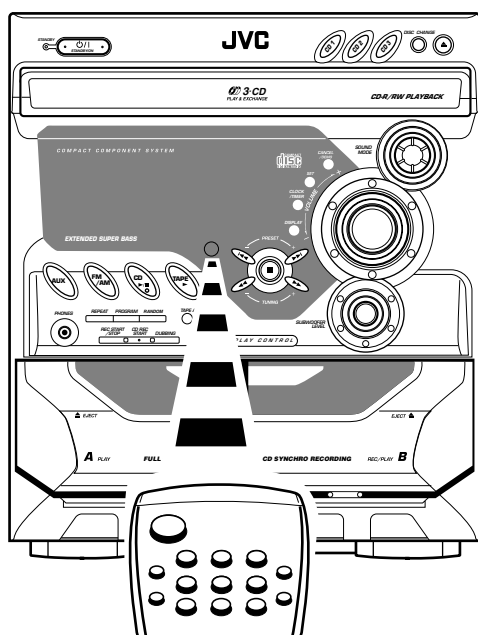
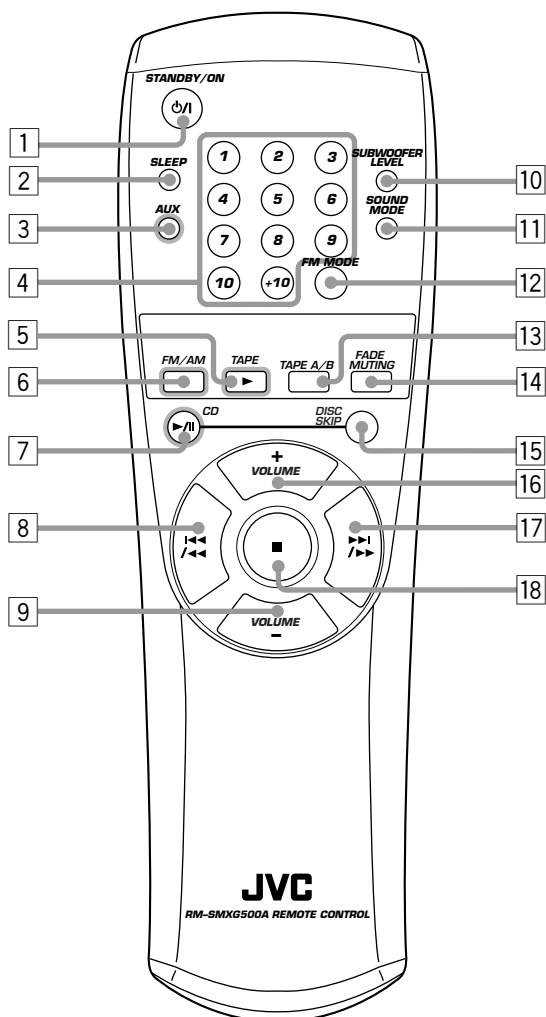

When using the remote control, point it at the remote sensor on the front panel.

Remote Control

- 1 STANDBY/ON button (9)
- 2 SLEEP button (21)
- 3 AUX button (9)
Pressing this button also turns on the unit.
- 4 Number buttons (11, 13)
- 5 TAPE button (9, 16)
Pressing this button also turns on the unit.
- 6 FM/AM button (9, 11)
Pressing this button also turns on the unit.
- 7 CD button (9, 12 – 15)
Pressing this button also turns on the unit.
- 8 (fast rewind/reverse search) button (11, 13, 16)
- 9 VOLUME – button (10)
- 10 SUBWOOFER LEVEL button (10)
- 11 SOUND MODE button (10)
- 12 FM MODE button (11)
- 13 TAPE A/B button (16)
- 14 FADE MUTING button (10)
- 15 DISC SKIP button (12)
- 16 VOLUME + button (10)
- 17 (fast forward/forward search) button (11, 13, 16)
- 18 (stop) button (12 – 18)

Unpacking

After unpacking, check to be sure that you have all the following items.

The number in the parentheses indicates the quantity of the pieces supplied.

- AM loop antenna (1)
- FM antenna (1)
- Remote control (1)
- Batteries (2)

If any is missing, consult your dealer immediately.

Putting the Batteries into the Remote Control

Insert the batteries—UM-4/AAA/IEC R03—into the remote control, by matching the polarity (+ and –) on the batteries with the + and – markings on the battery compartment. When the remote control can no longer operate the unit, replace both batteries at the same time.

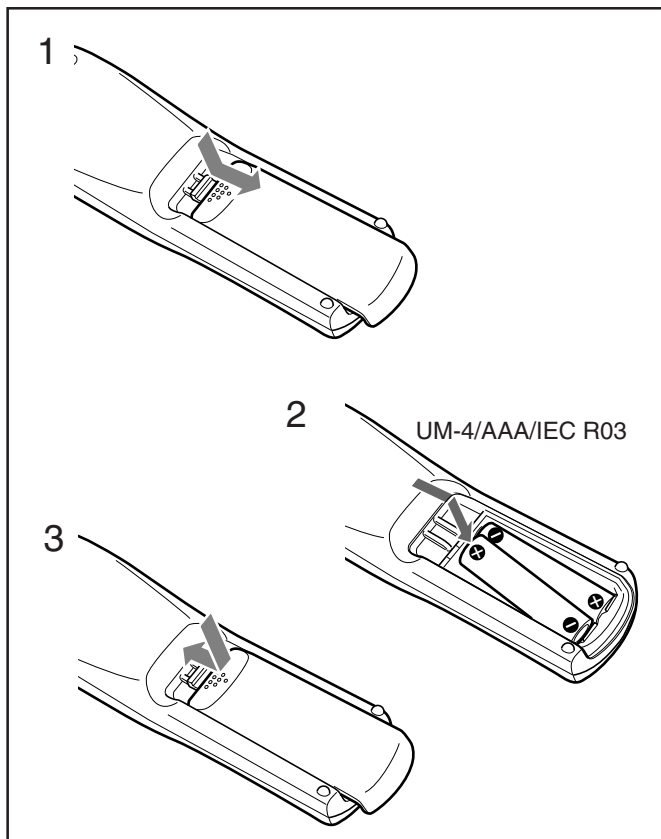

- DO NOT use an old battery together with a new one.
- DO NOT use different types of batteries together.
- DO NOT expose batteries to heat or flame.
- DO NOT leave the batteries in the battery compartment when you are not going to use the remote control for an extended period of time. Otherwise, it will be damaged from battery leakage.

Connecting Antennas

FM antenna

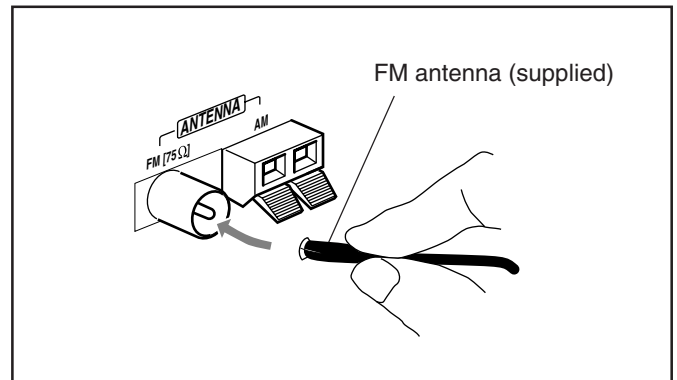

- 1 Attach the FM antenna to the FM [75 Ω] coaxial terminal.
- 2 Extend the FM antenna.
- 3 Fasten it up in the position which gives you the best reception, then fix it on the wall, etc.



About the supplied FM antenna

The FM antenna supplied with this unit can be used as temporary measure. If reception is poor, you can connect an outdoor FM antenna.

To connect an outdoor FM antenna

Before connecting it, disconnect the supplied FM antenna.

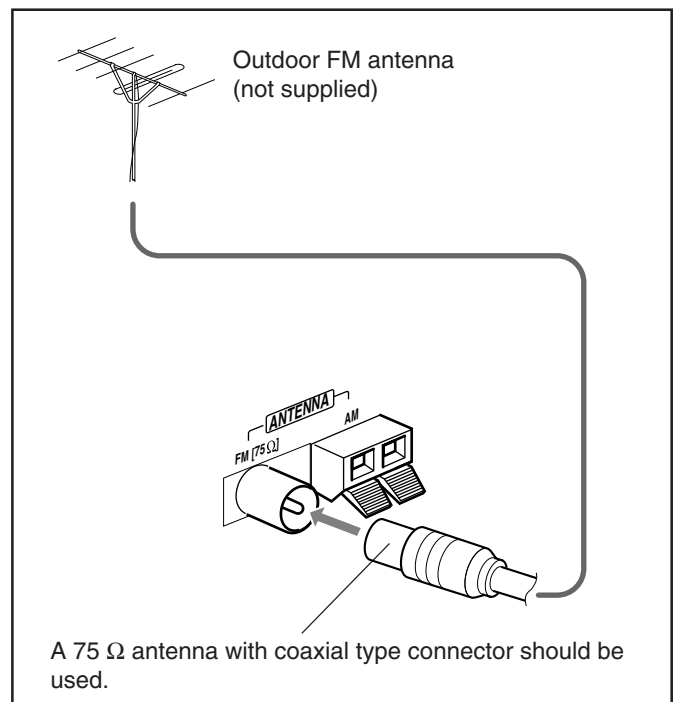

AM antenna

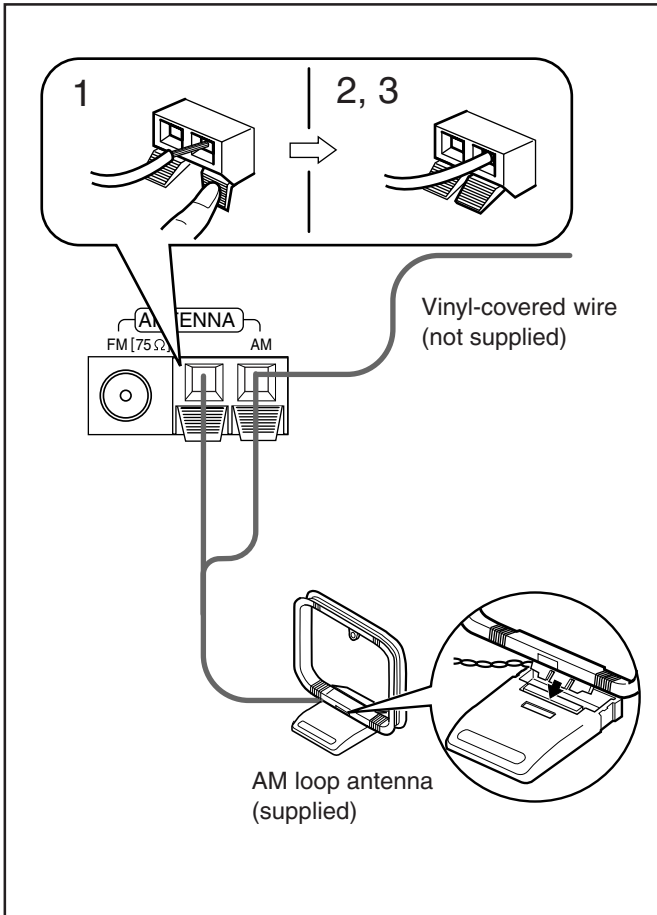

1 Press and hold the clamp of the AM terminal on the rear of the unit.

2 Insert the end of the AM loop antenna cord into the terminal.

- If the AM loop antenna wire is covered with vinyl, remove the vinyl by twisting it as shown in the diagram.

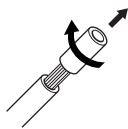

3 Release the finger from the clamp.

4 Turn the AM loop antenna until you have the best reception.

To connect an outdoor AM antenna

When reception is poor, connect a single vinyl-covered wire to the AM terminal and extend it horizontally. (The AM loop antenna must remain connected.)



For better reception of both FM and AM

- Make sure the antenna conductors do not touch any other terminals and connecting cords.
- Keep the antennas away from metallic parts of the unit, connecting cords, and the AC power cord.

Connecting Speakers



For MX-GT700:

DO NOT carry the speaker by holding the duct tube (on the top of the speaker).

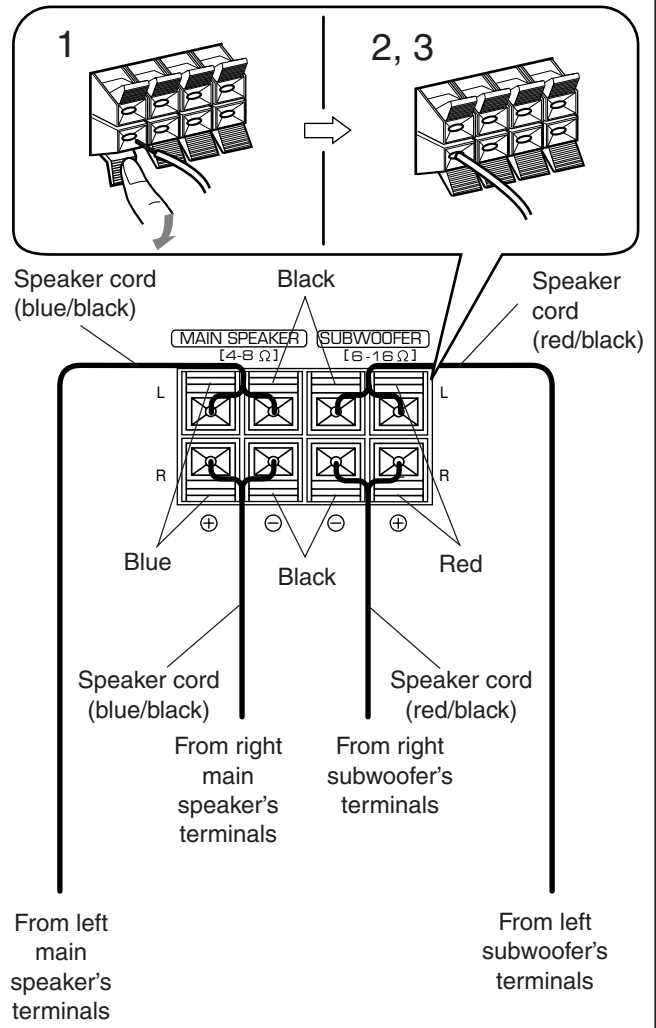

1 Press and hold the clamp of the speaker terminal on the rear of the unit.

2 Insert the end of the speaker cord into the terminal.

Match the polarity (colors): Blue (+) to blue (+) and black (-) to black (-); red (+) to red (+) and black (-) to black (-).

- If the wire is covered with vinyl, remove the vinyl by twisting it as shown in the diagram.

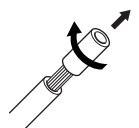

3 Release the finger from the clamp.

IMPORTANT: Use only speakers with the same speaker impedance as indicated by the speaker terminals on the rear of the unit.



Connecting Other Equipment

You can connect both analog and digital equipment.



- DO NOT connect any equipment while the power is on.
- DO NOT plug in any equipment until all connections are complete.

To connect an analog component

Be sure that the plugs of the audio cords are color coded: White plugs and jacks are for left audio signals, and red ones for right audio signals.

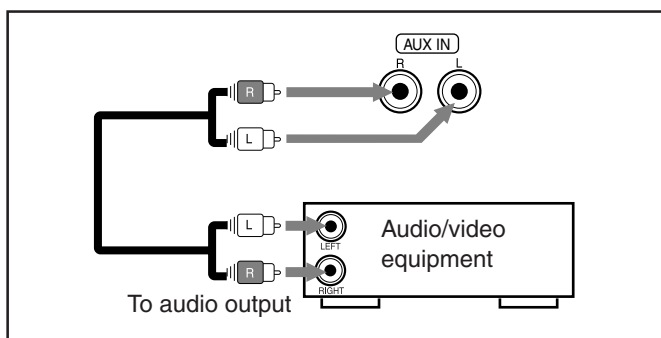

For playing the other equipment through this unit, connect between the audio output jacks on the other equipment and AUX IN jacks by using audio cords (not supplied).

To connect audio equipment with an optical digital input terminal

You can record CD sound onto the connected digital equipment.

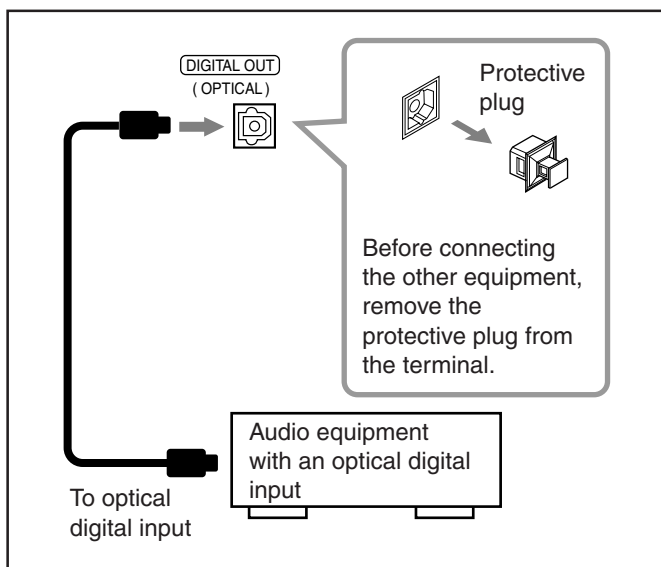

Connect an optical digital cord (not supplied) between the optical digital input terminal on the other equipment and the DIGITAL OUT [OPTICAL] terminal.

NOW, you can plug in the unit and other connected equipment FINALLY!

Canceling the Display Demonstration

When connecting the AC power cord into a wall outlet, the unit automatically starts display demonstration.

On the unit ONLY:

To cancel the display demonstration, press CANCEL/DEMO.



When you press other buttons

The display demonstration stops temporarily. It will start automatically again (if no operation is done for 2 minutes) until you cancel it by pressing CANCEL/DEMO.

To start the display demonstration manually

Press and hold CANCEL/DEMO again for more than 2 seconds.



Common Operations

Turning On or Off the Power

To turn on the unit, press STANDBY/ON so that the STANDBY lamp goes off.

WELCOME

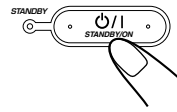

To turn off the unit (on standby), press STANDBY/ON again so that the STANDBY lamp lights up.

GOOD BYE

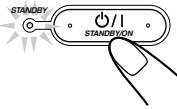

A little power is always consumed even while the unit is on standby.

To switch off the power supply completely, unplug the AC power cord from the AC outlet.



When you unplug the AC power cord or if a power failure occurs

The clock is reset to “-- : --” soon, while the tuner preset stations (see page 11) will be erased in a few days.

Setting the Clock

Before operating the unit any further, first set the clock built in this unit. You can set the clock whether the unit is on or off.

On the unit ONLY:

1 Press CLOCK/TIMER.

FM 1:20



The hour digits start flashing on the display.

2 Press or to adjust the hour, then press SET.

FM 5:00



The minute digits start flashing on the display.

- If you want to correct the hour after pressing SET, press CANCEL/DEMO. The hour digits start flashing again.

3 Press or to adjust the minute, then press SET.

CLOCK OK

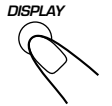
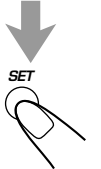
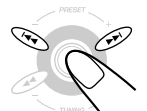

To check the clock time

Press DISPLAY while playing any source.

- Each time you press the button, the source indication and the clock time alternate on the display.

To adjust the clock again

If you have adjusted the clock before, you need to press CLOCK/TIMER repeatedly until “CLOCK” is selected.

- Each time you press the button, the clock/timer setting modes change as follows:

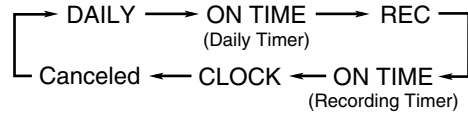

If there is a power failure

The clock loses the setting and is reset to “-- : --.” You need to set the clock again.

Selecting the Sources

To listen to the radio, press FM/AM. (See page 11.)

To play back CDs, press CD /||. (See pages 12 – 15.)

To play back tapes, press TAPE . (See page 16.)

To select the external equipment as the source, press AUX.

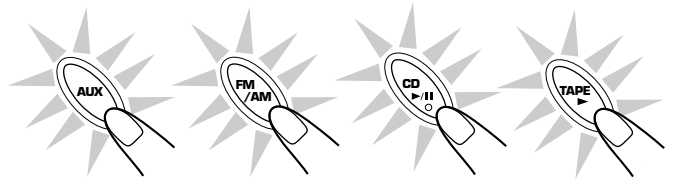

When you press the play button for a particular source (AUX, FM/AM, CD /||, and TAPE), the unit turns on (and the unit starts playing the source if it is ready—COMPU PLAY CONTROL).

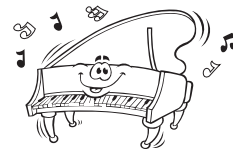

Adjusting the Volume

You can adjust the volume level only while the unit is turned on.

Turn the **VOLUME** control clockwise to increase the volume or counterclockwise to decrease it.

- The volume level can be adjusted in 32 steps (VOL MIN, VOL 1 — VOL 30, and VOL MAX).

VOL 15

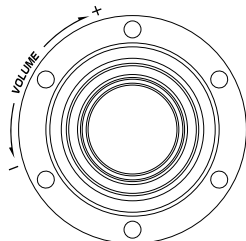

When using the remote control, press **VOLUME +** to increase the volume or press **VOLUME -** to decrease it.



For private listening

Connect a pair of headphones to the PHONES jack. No sound comes out of the speakers. Be sure to turn down the volume before connecting or putting on headphones.



DO NOT turn off (on standby) the unit with the volume set to an extremely high level; otherwise, a sudden blast of sound can damage your hearing, speakers and/or headphones when you turn on the unit or start playing any source next time. **REMEMBER** you cannot adjust the volume level while the unit is on standby.

To turn down the volume level temporarily

Press **FADE MUTING** on the remote control. The volume level gradually decreases to “VOL MIN.”



To restore the sound, press the button again.

Reinforcing the Bass Sound

This function only affects the playback sound, not your recording.

Turn the **SUBWOOFER LEVEL** control clockwise to increase the subwoofer sound or counterclockwise to decrease it.

- The subwoofer level can be adjusted in 4 steps (LEVEL 1 — LEVEL 4.)
- If you turn the control clockwise up to the LEVEL 4, “MAX” flashes on the display for a few seconds.

SUBWOOFER LEVEL indicator always lights up while the unit is on.



When using the remote control, press **SUBWOOFER LEVEL** to adjust the subwoofer level. Each time you press the button, the subwoofer level changes as LEVEL 1 → LEVEL 2 → LEVEL 3 → LEVEL 4 → (back to the beginning).

Selecting the Sound Modes

This function only affects the playback sound, not your recording.

You can select one of the 6 preset sound modes (3 surround modes and 3 SEA—Sound Effect Amplifier—modes).

To select the sound modes, turn the **SOUND MODE** control until the sound mode you want appears on the display.

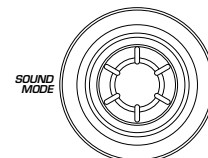

SOUND MODE indicator also lights up on the display

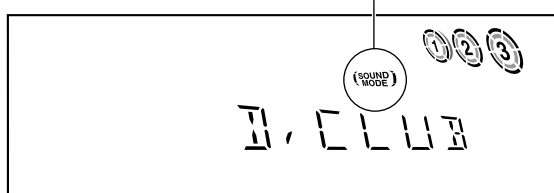

- As you turn the control, the sound modes change as follows:

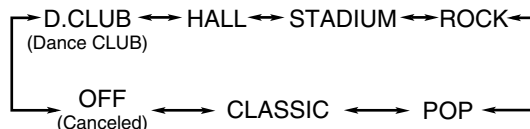

Surround modes*:

- D.CLUB** : Increases resonance and bass.
- HALL** : Adds depth and brilliance to the sound.
- STADIUM**: Adds clarity and spreads the sound, like in an outdoor stadium.

SEA (Sound Effect Amplifier) modes:

- ROCK** : Boosts low and high frequency. Good for acoustic music.
- POP** : Good for vocal music.
- CLASSIC** : Good for classical music.
- OFF** : Cancels the sound mode.

* Surround elements are added to the SEA elements to create being-there feeling in your room.

When one of these modes is selected, the **SOUND MODE** indicator lights up as — **(SOUND MODE)**

While one of the SEA modes (SEA elements without surround elements) is selected, the **SOUND MODE** indicator lights up as — **SOUND MODE**

When using the remote control, press **SOUND MODE** to select the sound mode.

- Each time you press the button, the sound modes change as follows:

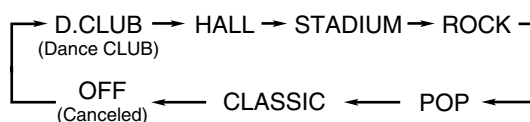

Listening to the Radio



Tuning in a Station

1 Press FM/AM.

The unit automatically turns on and tunes in the previously tuned station (either FM or AM).

- Each time you press the button, the band alternates between FM and AM.



2 Start searching for stations.

On the unit:

Press and hold **TUNING +** or **TUNING -** for more than 1 second.

On the remote control:

Press and hold **◀◀/◀◀** or **▶▶/▶▶** for more than 1 second.

The unit starts searching for stations and stops when a station of sufficient signal strength is tuned in.

If a program is broadcast in stereo, the ST (stereo) indicator lights up.

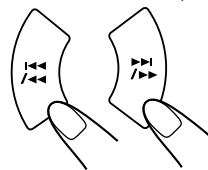
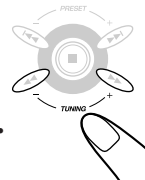

To stop during searching, press **TUNING +** or **TUNING -** (or **◀◀/◀◀** or **▶▶/▶▶** on the remote control).



When you press **TUNING +** or **TUNING -** (or **◀◀/◀◀** or **▶▶/▶▶** on the remote control) briefly and repeatedly

The frequency changes step by step.

To change the FM reception mode

When an FM stereo broadcast is hard to receive or noisy, press **FM MODE** on the remote control so that “MONO” appears and MONO indicator also lights up on the display. Reception improves.



To restore the stereo effect, press **FM MODE** again so that “STEREO” appears.

In this stereo mode, you can hear stereo sounds when a program is broadcast in stereo.

Presetting Stations

You can preset 30 FM and 15 AM stations.

In some cases, test frequencies have been already memorized for the tuner since the factory examined the tuner preset function before shipment. This is not a malfunction. You can preset the stations you want into memory by following the presetting method.

- There is a time limit in doing the following steps. If the setting is canceled before you finish, start from step 1 again.

On the unit ONLY:

1 Tune in the station you want to preset (in this example, of FM 87.50).

- See “Tuning in a Station.”

FM 87.50

2 Press SET.

SET



3 Press PRESET + or PRESET - to select a preset number.

P-01

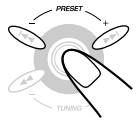

4 Press SET again.

STORED



The tuned station in step 1 is stored in the preset number selected in step 3.

- Storing a new station on a used number erases the previously stored one.



When you unplug the AC power cord or if a power failure occurs

The preset stations will be erased in a few days. If this happens, preset the stations again.

Tuning in a Preset Station

1 Press FM/AM.

The unit automatically turns on and tunes in the previously tuned station (either FM or AM).

- Each time you press the button, the band alternates between FM and AM.

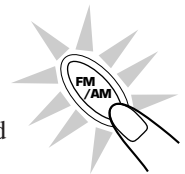

2 Select a preset number.

On the unit:

Press **PRESET +** or **PRESET -**.

On the remote control:

Press the number buttons.

Ex.: For preset number 5, press 5.

For preset number 15, press +10 then 5.

For preset number 20, press +10, then 10.

For preset number 25, press +10, +10, then 5.

For preset number 30, press +10, +10, then 10.

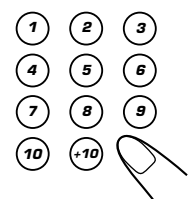

Playing Back CDs

Continued 

This unit has been designed to playback the following CDs: Audio CD, CD-R, and CD-RW.

When playing a CD-R or CD-RW

User-edited CD-Rs (CD-Recordable) and CD-RWs (CD-ReWritable) can be played back when they are already **“finalized.”**

- You can play back your original CD-Rs or CD-RWs recorded in music CD format **ONLY**. (If CD-RWs have been recorded in different format, erase all the data on CD-RWs completely before re-recording on the discs.)

 **DO NOT** play back CD-Rs or CD-RWs recorded the sound files such as MP3.

- Before playing back CD-Rs or CD-RWs, read their instructions or cautions carefully.
- Some CD-Rs or CD-RWs may not be played back on this unit because of their disc characteristics, damage or stain on them, or if the player’s lens is dirty.

Important notices:

- In general, you will have the best performance by keeping your CDs and the mechanism clean.
 - Store CDs in their cases, and keep them in cabinets or on shelves.
 - Keep the unit’s carrousel closed when not in use.
- Continuous use of irregular shaped discs (heart-shape, octagonal, etc.) can damage the disc rotating mechanism.

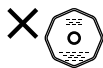
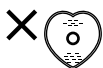

- CD-RWs may require a longer readout time since the reflectance of CD-RWs is lower than for regular CDs.

Loading CDs

1 Press .

The unit automatically turns on and the carrousel comes out.



2 Place one or two discs correctly on the front recesses of the disc tray, with its label side up.

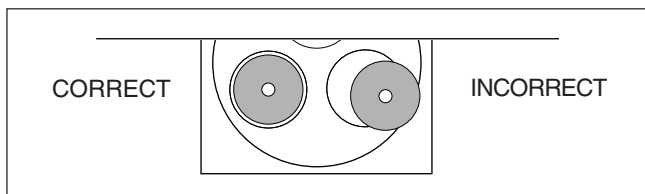

- When using a CD single (8 cm), place it on the inner circle of the disc tray.

3 If you wish to load a third disc, press **DISC CHANGE** on the unit or **DISC SKIP** on the remote control.

The disc tray rotates by 120°.



4 Press again.

The carrousel closes.



About the disc indicators

Each disc indicator corresponds to the disc tray of the same number.

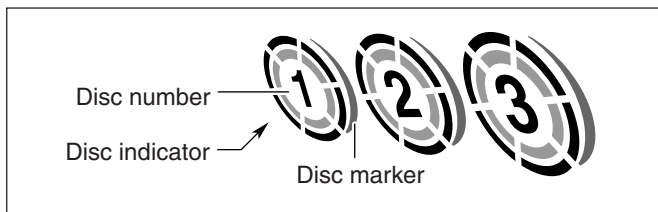



- The disc marker lights up for the disc number you have selected.
- The disc indicator rotates while the corresponding CD is being played.
- The disc indicator goes off when the unit has detected that there is no CD on the corresponding disc tray.

Playing Back CDs—All Disc and One Disc

You can play all loaded CDs continuously—All Disc play, or one selected disc—One Disc play.

All Disc play

1 Load CDs.

- If the current playing source is not the CD player, press CD , then  before going to the next step.

2 Press **REPEAT** repeatedly so that the **ALL DISC** indicator lights up on the display.

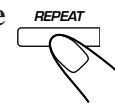

Track number of the currently playing disc (Track numbers exceeding 16 are not displayed.)

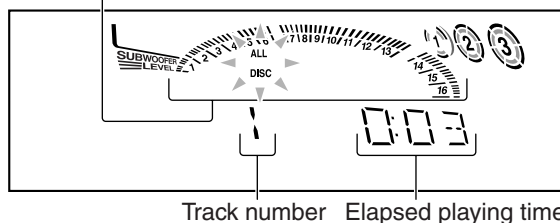

- Each time you press the button, the indication on the display changes as follows:



* See page 15.

3 Press one of the disc number buttons (CD1, CD2 or CD3) for the disc you want to start to play from.

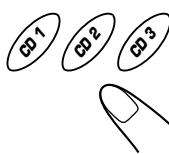

CD play starts from the first track of the selected disc.

- Pressing CD ►/|| instead of the disc number buttons starts playing back if a CD is on the trays.

To stop during play, press ■.

To remove the disc, press ▲.



CD playback sequence

When 3 CDs are loaded on the disc trays, they are played in one of the following sequences.

- When CD1 is pressed : CD1 ⇒ CD2 ⇒ CD3 (then stops)
- When CD2 is pressed : CD2 ⇒ CD3 ⇒ CD1 (then stops)
- When CD3 is pressed : CD3 ⇒ CD1 ⇒ CD2 (then stops)
- * When only 2 CDs are loaded, they are played in the same order, but the disc tray without a CD is skipped.

One Disc play

When more than 2 CDs are loaded on the disc trays, you can select one particular disc to be played back.

1 Load CDs.

- If the current playing source is not the CD player, press CD ►/||, then ■ before going to the next step.

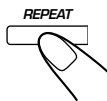

2 Press REPEAT repeatedly so that the 1 DISC indicator lights up on the display.

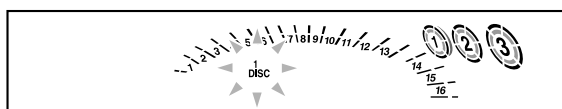

- Each time you press the button, the indication on the display changes as follows:

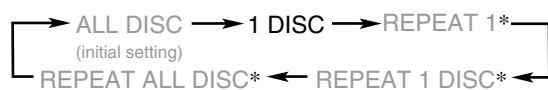

* See page 15.

3 Press one of the disc number buttons (CD1, CD2 or CD3) you want to listen.

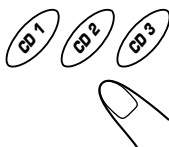

Playback stops when all tracks of the selected disc are played once and resumes to All Disc play.

To stop during play, press ■.

To remove the disc, press ▲.

To exit from One Disc Play, press REPEAT repeatedly so that ALL DISC indicator lights up on the display.



The following operations will also cancel the One Disc play and restore All Disc play when—

- Turning off the power,
- Ejecting the carousel, or
- Changing the source to play.

Basic CD Operations

While playing a CD, you can do the following operations.

To exchange CDs during playback of another

Press DISC CHANGE to change the CD and the carousel comes out.



If you change CDs during play, the current play will not stop until all CDs you have changed are played.

To close the carousel, press DISC CHANGE or ▲.

To skip to the another CD in the carousel

Press DISC SKIP on the remote control.



To stop play for a moment

Press CD ►/||.

While pausing, “PAUSE” appears on the display.

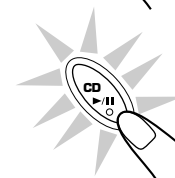

To resume play, press CD ►/|| again.

To locate a particular point in a track

During play, press and hold ◀◀ or ▶▶.

- ◀◀: Fast reverses the disc.
- ▶▶: Fast forwards the disc.

When using the remote control, press and hold ◀◀/◀◀ or ▶▶/▶▶.



To go to another track

Press ◀◀ or ▶▶ repeatedly before or during playback.

- ◀◀: Goes back to the beginning of the current or previous tracks.
- ▶▶: Skips to the beginning of the next or succeeding tracks.

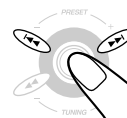

If you press and hold ◀◀ or ▶▶ on the unit before playing

The track number keeps changing until you release it.

To go to another track directly using the number buttons

Pressing the number button(s) before or during play allows you to start playing the track number you want.

- Ex.: For track number 5, press 5.
 For track number 15, press +10, then 5.
 For track number 20, press +10, then 10.
 For track number 32, press +10, +10, +10, then 2.

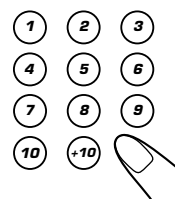

Programming the Playing Order of the Tracks —Program Play

You can arrange the order in which the tracks play before you start playing. **You can program up to 32 tracks.**

- To use Repeat play (see page 15) for Program play, press REPEAT after starting Program play.

On the unit ONLY:

1 Load CDs.

- If the current playing source is not the CD player, press CD ►/II, then ■ before going to the next step.

2 Press PROGRAM so that “PROGRAM” appears on the display.

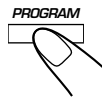

The PRGM (program) indicator also lights up on the display.

- All Disc play mode is selected automatically. You cannot select One Disc play mode for Program play.

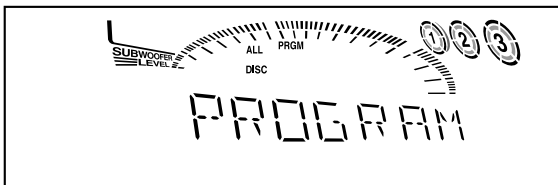

- If a program has been stored in memory, the program is called up.

3 Press one of the disc number buttons (CD1, CD2, and CD3) to select the disc number you want to play.

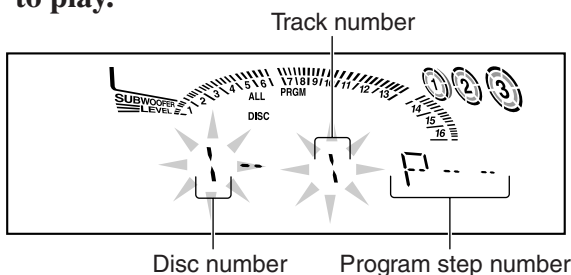
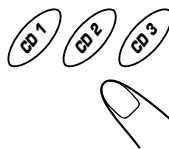

4 Press ◀◀ or ▶▶ to select the track number, then press SET.

Each time you select a track and press SET, the selected track number is added to the track number indicator.

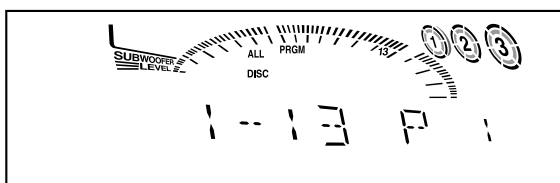
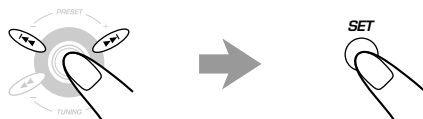

5 Program other tracks you want.

- To program tracks from the same disc, repeat step 4.
- To program tracks from a different disc, repeat steps 3 and 4.

6 Press CD ►/II.

The tracks are played in the order you have programmed.

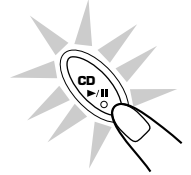

To stop during play, press ■.

To exit from Program play mode, press PROGRAM again before or after play so that the unit enters All Disc play mode. (The program you have made is stored in memory until you turn off the unit, eject the carousel, or erase the program.)

- Program play mode is also canceled when you press ▲.

To modify the program

Before playing, you can erase the last programmed track shown on the display by pressing CANCEL/ DEMO.



- Each time you press the button, the last programmed track is erased from the program.

To check the program during play, press ▶▶ (or ◀◀) so that the playing track will change according to the program (or reverse) order.

To add tracks in the program before play, simply select the disc numbers and/or track numbers you want to add by following steps 3 and 4 of the programming procedure.

To erase the entire program before or during play, press ■ twice.

- Turning the power off or ejecting the carousel will also erase the stored memory.



notes If you try to program a 33rd track “FULL” will appear on the display.



notes If your entry is ignored

You have tried to program a track from an empty tray, or a track number that does not exist on the CD. Such entries are ignored.



Playing at Random—Random Play

The tracks of the selected CD will play at random.

- To use Random play mode, you have to cancel the Program play mode.

1 Load a CD.

2 Press one of the disc number buttons (CD1, CD2, and CD3) for the disc you want to play, then press ■.

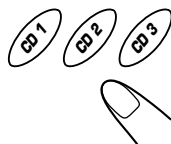

3 Press RANDOM so that “RANDOM” appears on the display.



The RANDOM indicator also lights up on the display.

- Activating Random play cancels Repeat play or All Disc play. (One Disc is automatically selected.)

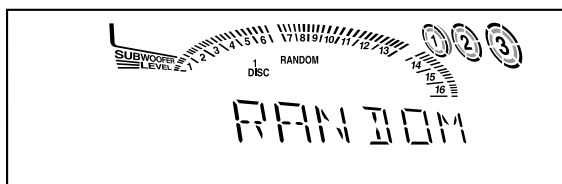

- The tracks are played automatically at random. Random play ends when all tracks are played once.

To stop during play, press ■.

To exit from Random play mode, press RANDOM again during play so that the unit enters All Disc play mode.

- Random play is also canceled when you press ▲.



If you press ◀◀ or ▶▶

Skips to the next track selected randomly.

Repeating Tracks or CDs—Repeat Play

You can have all the CDs, the program or the individual track currently playing repeat as many times as you like.

To repeat play, press REPEAT during or before playing.

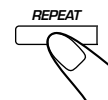

- Each time you press the button, Repeat play mode changes as follows, and the following indicator lights up on the display:

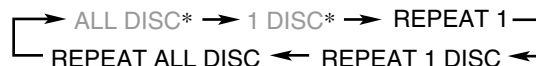

REPEAT 1 : Repeats one track on one CD.

REPEAT 1 DISC** : Repeats all the tracks on one CD.

REPEAT ALL DISC: Repeats all the tracks on all the CDs.

* See page 12.

** REPEAT 1 DISC is not used for Program play.

To cancel Repeat play, press REPEAT repeatedly until the REPEAT indicator (REPEAT 1, REPEAT 1 DISC or REPEAT ALL DISC) goes off from the display.

- Repeat play and Random play cannot be used at the same time.
- Repeat play is also canceled when you press ▲.

Prohibiting Disc Ejection—Tray Lock

You can prohibit CD ejection from the unit and can lock the carrousel.

- This operation is possible only while the unit is on with CD selected as the source.

On the unit ONLY:

To prohibit disc ejection, press ▲ for the carrousel while holding ■.

“LOCKED” appears for a while, and the carrousel is locked.

To cancel the prohibition and unlock the carrousel, press ▲ for the carrousel while holding ■.

“UNLOCKED” appears for a while, and the carrousel is unlocked.



If you try to eject CDs

“LOCKED” appears to inform you that the Tray Lock is in use.

Playing Back Tapes

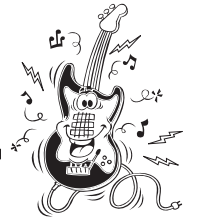

Playing Back a Tape

1 Press EJECT (▲) for the deck you want to use.

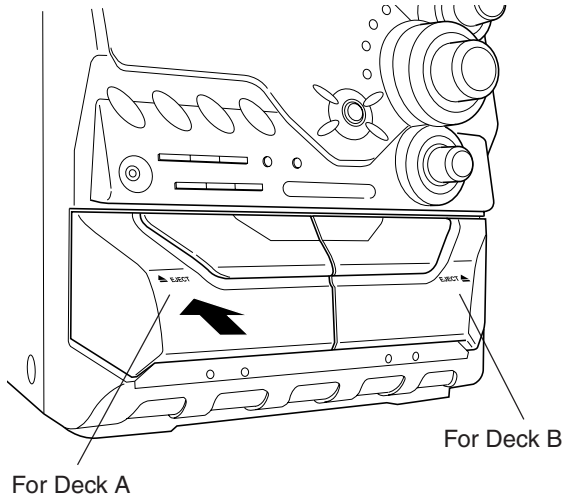

2 Put a cassette in, with the exposed part of the tape down and the side you want to play facing front.

- You can play back only type I tapes.

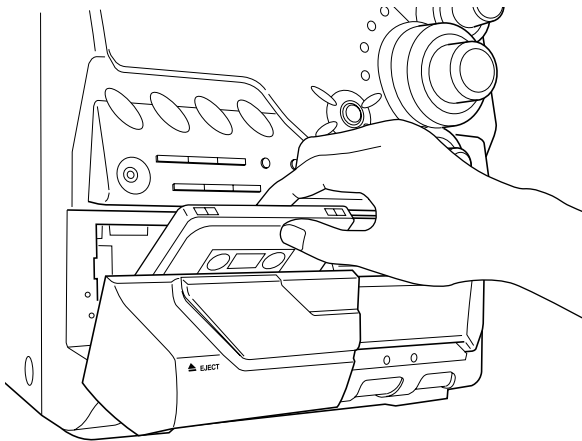

To stop during play, press ■.

To operate the other deck, press TAPE A or TAPE B (or TAPE A/B on the remote control), then TAPE ►.

To fast-forward the tape, press ►► (or ►►/►► on the remote control). The tape running indicator (►) starts flashing quickly.

To rewind the tape, press ◀◀ (or ◀◀/◀◀ on the remote control). The tape running indicator (◀) starts flashing quickly.

To remove the cassette, press ▲ EJECT for deck A or EJECT ▲ for deck B.

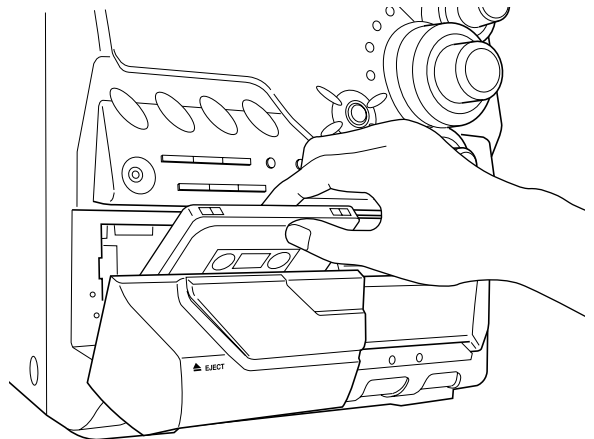
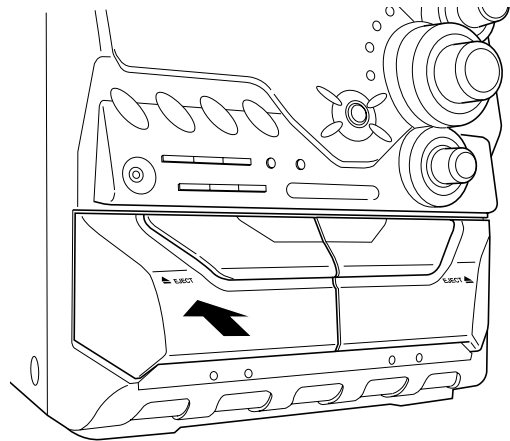

3 Close the cassette holder gently.

If you put cassettes in both decks A and B, the last deck which you have put a cassette into is selected.

To operate the other deck, press TAPE A or TAPE B (or TAPE A/B on the remote control).

4 Press TAPE ►.

The tape play starts and the tape running indicator (►) starts flashing slowly.

When the tape plays to the end, the deck automatically stops.



The use of the C-120 or thinner tape is not recommended, since characteristic deterioration may occur and this tape easily jams in the pinch-rollers and the capstans.

Recording

IMPORTANT:

- It should be noted that it may be unlawful to re-record pre-recorded tapes, records, or discs without the consent of the owner of copyright in the sound or video recording, broadcast or cable program and in any literary, dramatic, musical, or artistic embodied therein.
- The recording level is automatically set correctly, so it is not affected by the VOLUME control and the SUBWOOFER LEVEL control. Thus, during recording you can adjust the sound you are actually listening to without affecting the recording level.
- While recording, you can hear sound modes through the speakers or headphones. However, the sound is recorded without these effects (see page 10).
- If recordings you have made have excessive noise or static, the unit may be too close to a TV. Place the unit away from the TV.
- You can use type I tape for recording.

To protect your recording

Cassettes have two small tabs on the back to protect unexpected erasure or re-recording.

To protect your recording, remove these tabs.

To re-record on a protected tape, cover the holes with adhesive tape.

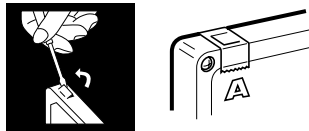

To keep the best recording and playback sound quality

If the heads, capstans, and pinch rollers of the cassette decks become dirty, the following will occur:

- Impaired sound quality
- Discontinuous sound
- Fading
- Incomplete erasure
- Difficulty in recording

To clean the head, capstan, and pinch roller

Use a cotton swab moistened with alcohol.

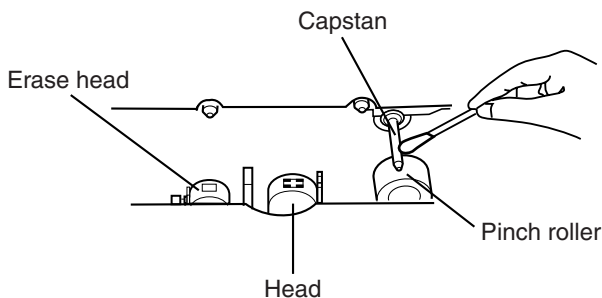

To demagnetize the head

Turn off the unit, and use a head demagnetizer (available at electronics and audio shops).

Recording a Tape on Deck B

On the unit ONLY:

1 Press EJECT ▲ for deck B.

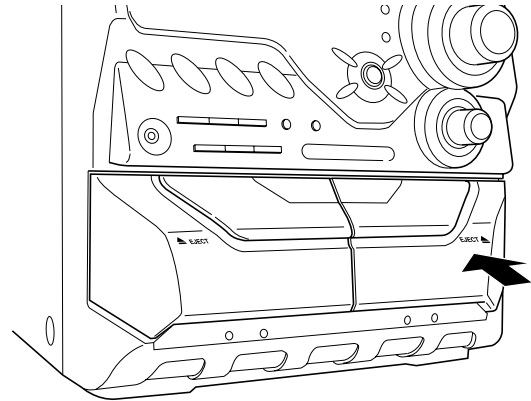

2 Put in a recordable cassette, with the exposed part of the tape down and the side you want to record facing front.

3 Close the cassette holder gently.

4 Start playing the source—FM, AM, CD player or auxiliary equipment connected to AUX IN jacks.

- For duplicating tapes, see “Dubbing Tapes” on page 18.
- For recording from CD, see “CD Synchronized Recording” on page 18.

5 Press REC START/STOP.

The REC (recording) indicator lights up on the display and recording starts.



To stop during recording, press REC START/STOP again or ■.

To remove the cassette, press EJECT ▲ for deck B.

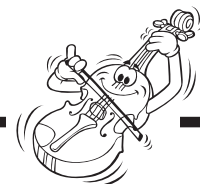

Dubbing Tapes

On the unit ONLY:

1 Press **TAPE** ►, then ■.

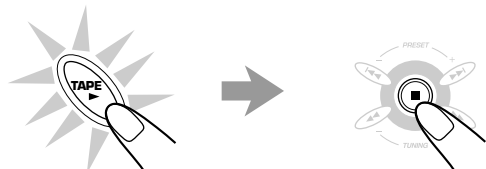

2 Put the source cassette in deck A, and a recordable cassette into deck B.

3 Press **DUBBING**.

Dubbing starts.
“DUBBING” appears, and the REC (recording) indicator lights up on the display.

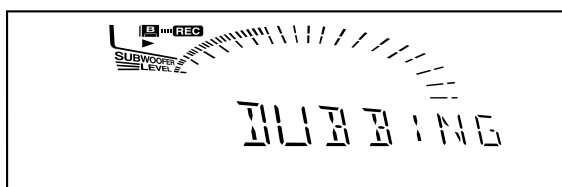

To stop during dubbing, press **REC START/STOP** or ■.

To remove the cassette, press ▲ **EJECT** for deck A and **EJECT** ▲ for deck B.

CD Synchronized Recording

You can easily record a CD onto a tape.

- You can also record the tracks in order you have made the program.

On the unit ONLY:

1 Put a recordable cassette into deck B.

2 Place a disc correctly on the circle of the disc tray, with its label side up.

3 Press one of the disc number buttons (**CD1**, **CD2**, and **CD3**) to select the disc, then ■.

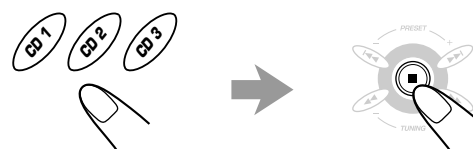

4 Press **CD REC START**.

“CD REC” appears, and the REC (recording) indicator lights up on the display.

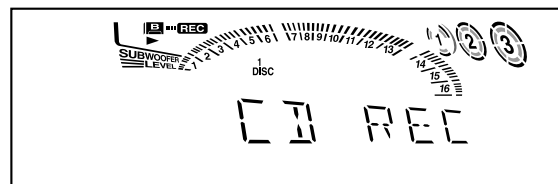

Deck B starts recording and the CD player starts playing.
When the recording is done, the CD player and deck B stop.

To stop during **CD Synchronized Recording**, press **REC START/STOP** or ■.

To remove the cassette, press **EJECT** ▲ for deck B.

Using the Timers

There are three timers available—Daily Timer, Recording Timer, and Sleep Timer.

Before using the timers, you need to set the clock built in the unit. (See “Setting the Clock” on page 9.)

Using Daily Timer

With Daily Timer, you can wake to your favorite music or radio program. You can set the timer whether the unit is on or off.

How Daily Timer actually works

The unit automatically turns on, set the volume level to the preset level, and starts playing the specified source when the on-time comes (the ☺ indicator flashes while the timer is operating). Then, when the off-time comes, the unit automatically turns off (stands by).

Daily Timer works every day unless you cancel it.

- There is a time limit in doing the following steps. If the setting is canceled before you finish, start from step 1 again.
- If you have made a mistake while setting timer, press CANCEL/DEMO. (However, this does not always work. If CANCEL/DEMO does not work, press CLOCK/TIMER repeatedly and start from step 1 again.)

Before you start...

- *When using a CD as the source to play:*
—Make sure there is a CD on the currently selected disc number tray.
- *When using a tape as the source to play:*
—Make sure that a tape is in the deck whose deck indicator (A or B) is lit on the display.
- *When using the external component as the source to play:*
—Set the timer equipped with the external component at the same time.

On the unit ONLY:

1 Press CLOCK/TIMER repeatedly until “DAILY” appears on the display.

☺ indicator lights up and the DAILY (daily timer) indicator starts flashing on the display.

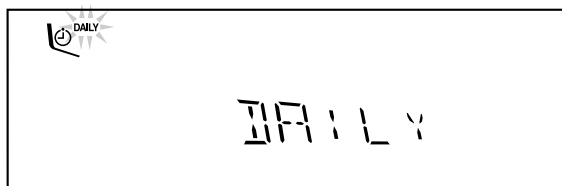

- Each time you press the button, the timer setting modes change as follows:



2 Press CLOCK/TIMER again.

“ON TIME” appears for 2 seconds, then the unit enters on-time setting mode.

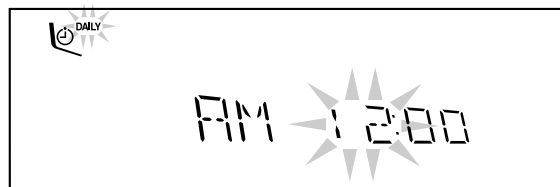

3 Set the on-time you want the unit to turn on.

- 1) Press ◀◀ or ▶▶ to set the hour, then press SET.
 - 2) Press ◀◀ or ▶▶ to set the minute, then press SET.
- “OFF TIME” appears for 2 seconds, then the unit enters off-time setting mode.

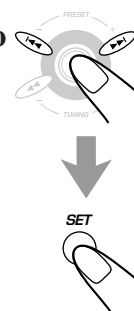

4 Set the off-time you want the unit to turn off (on standby).

- 1) Press ◀◀ or ▶▶ to set the hour, then press SET.
 - 2) Press ◀◀ or ▶▶ to set the minute, then press SET.
- The unit enters source selecting mode.

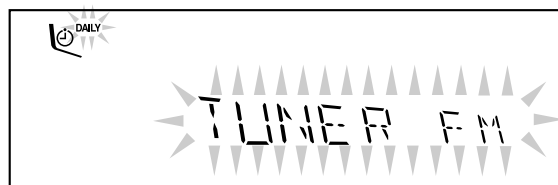
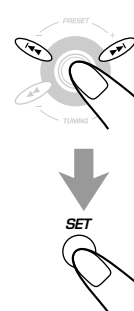

5 Press ◀◀ or ▶▶ to select the source to play, then press SET.

- Each time you press ◀◀ or ▶▶, the source changes as follows:

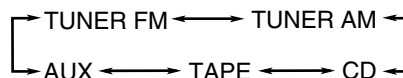

TUNER FM : tunes in to a specified preset FM station.

→ go to step 6.

TUNER AM : tunes in to a specified preset AM station.

→ go to step 6.

CD : plays a disc from the first track.

→ go to step 7.

TAPE : plays a tape in deck A or B.

→ go to step 7.

AUX : plays an external source.

→ go to step 7.

6 Select the preset station number.

Press **◀◀** or **▶▶** to select the preset station number, then press **SET**.
The unit enters volume setting mode.

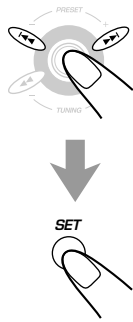
**7 Press ◀◀ or ▶▶ to set the volume level.**

You can select the volume level from **VOL MIN**, **VOL 1 — VOL 30**, and **VOL MAX**.

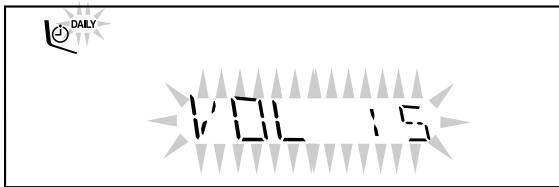
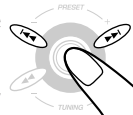
**8 Press SET to complete the Daily Timer setting.**

The **DAILY** (daily timer) indicator stops flashing and remains lit. The settings you have done are shown on the display in sequence for your confirmation.

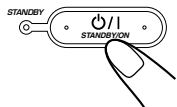
**9 Press ⏻/STANDBY/ON to turn off the unit (on standby) if you have set the Daily Timer with the unit turned on.**

If the unit is turned on when the timer-on time comes Daily Timer does not work.

To turn on or off Daily Timer after its setting is done**1 Press CLOCK/TIMER repeatedly until “DAILY” appears on the display.****2 To turn off the Daily Timer, press CANCEL/DEMO.**

The **DAILY** (daily timer) indicator goes off from the display (“OFF” appears for a while). The Daily Timer is canceled, but the setting for the Daily Timer remains in memory until you change it.

**To turn on the Daily Timer, press SET.**

The **DAILY** (daily timer) indicator lights up on the display. The settings you have done are shown on the display in sequence for your confirmation.

**Using Recording Timer**

With Recording Timer, you can make a tape of a radio broadcast automatically. You can set the timer whether the unit is on or off.

How Recording Timer actually works

The unit automatically turns on, tunes into the specified station, sets the volume level to “VOL MIN,” and starts recording when the on-time comes (the  indicator flashes while the timer is operating). Then, when the off-time comes, the unit automatically turns off (stands by).

Recording Timer works only once, but the timer setting remains in memory until you change it.

- There is a time limit in doing the following steps. If the setting is canceled before you finish, start from step **2** again.
- If you have made a mistake while setting the timer, press **CANCEL/DEMO**. (However, this does not always work. If **CANCEL/DEMO** does not work, press **CLOCK/TIMER** repeatedly and start from step **2** again.)

On the unit ONLY:**1 Put a recordable cassette into deck B.****2 Press CLOCK/TIMER repeatedly until “REC” appears on the display.**

 indicator lights up and the **REC** (recording timer) indicator also starts flashing on the display.

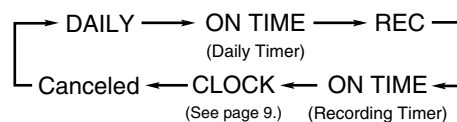

- Each time you press the button, the timer setting modes change as follows:

**3 Press CLOCK/TIMER again.**

“ON TIME” appears for 2 seconds, then the unit enters on-time setting mode.

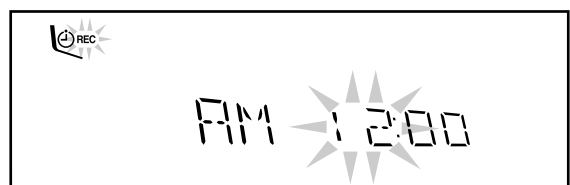



4 Set the on-time you want the unit to turn on.

- 1) Press **◀** or **▶** to set the hour, then press **SET**.
- 2) Press **◀** or **▶** to set the minute, then press **SET**.
“OFF TIME” appears for 2 seconds, then the unit enters off-time setting mode.

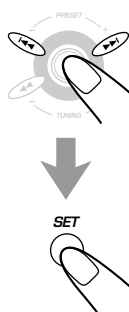

5 Set the off-time you want the unit to turn off (on standby).

- 1) Press **◀** or **▶** to set the hour, then press **SET**.
- 2) Press **◀** or **▶** to set the minute, then press **SET**.
The unit enters preset station selecting mode.

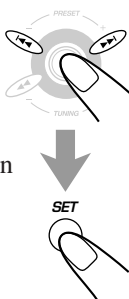

6 Select the preset station.

- 1) Press **◀** or **▶** to select the band (“TUNER FM” or “TUNER AM”), then press **SET**.
- 2) Press **◀** or **▶** to select a preset channel number, then press **SET**.
The REC (recording timer) indicator stops flashing and remains lit. The settings you have done are shown on the display in sequence for your confirmation.

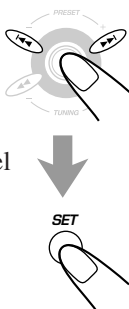

7 Press **⏻/STANDBY/ON** to turn off the unit (on standby) if necessary.

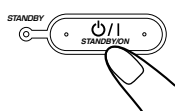

About the recording source

If you change the source while recording, the recording source also changes.

To turn on or off Recording Timer after its setting is done

- 1 Press **CLOCK/TIMER** repeatedly until “REC” appears on the display.



- 2 To turn off the Recording Timer, press **CANCEL/DEMO**.



The REC (recording timer) indicator goes off from the display (“OFF” appears for a while). The Recording Timer is canceled, but the setting for the Recording Timer remains in memory until you change it.

To turn on the Recording Timer, press SET.
The REC (recording timer) indicator lights up on the display. The settings you have done are shown on the display in sequence for your confirmation.



Using Sleep Timer

With Sleep Timer, you can fall asleep to music. You can set Sleep Timer when the unit is turned on.

How Sleep Timer actually works

The unit automatically turns off after the specified time length passes.

On the remote control ONLY:

1 Press SLEEP.

The time length until the shut-off time appears and the SLEEP indicator starts flashing on the display.



- Each time you press the button, the time length changes as follows:

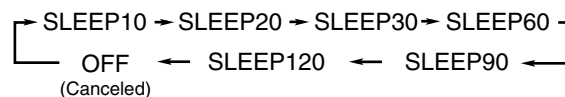

2 Wait for about 5 seconds after specifying the time length.

The SLEEP indicator stops flashing and remains lit.

To check the remaining time until the shut-off time, press SLEEP once so that the remaining time until the shut-off time appears for about 5 seconds.

To change the shut-off time, press SLEEP repeatedly until the desired time length appears on the display.

To cancel the setting, press SLEEP repeatedly until “OFF” appears on the display so that the SLEEP indicator goes off from the display.

- Sleep Timer is also canceled when you turn off the unit.

Timer Priority

Since each timer can be set separately, you may wonder what happens if the setting for these timers overlaps. Here are some examples.

- **Recording Timer has priority over Daily Timer.**

If Recording Timer is set to come on while Daily Timer is operating, Daily Timer is canceled and Recording Timer start working.

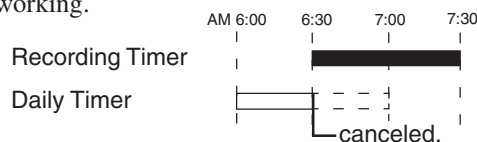

- If Sleep Timer overlaps with another timer (either Daily Timer or Recording Timer), a timer with the earlier shut-off time has priority.

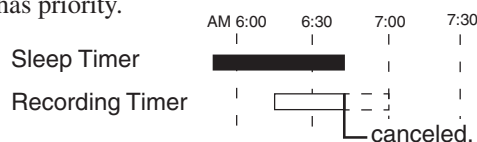

When using the Recording Timer and Sleep Timer at the same time, pay special attention to the shut-off time.

Maintenance



To get the best performance of the unit, keep your discs, tapes, and mechanism clean.

Cleaning the unit

• Stains on the unit

Should be wiped off with a soft cloth. If the unit is heavily stained, wipe it with a cloth soaked in water-diluted neutral detergent and wrung well, then wipe clean with a dry cloth.

• Avoid the following since they may cause damage to the unit.

- DO NOT wipe it with a hard cloth.
- DO NOT wipe it strong.
- DO NOT wipe it with thinner or benzine.
- DO NOT apply any volatile substance such as insecticides to it.
- DO NOT allow any rubber or plastic to remain in contact with it for a long time.

Handling discs



- Remove the disc from its case by holding it at the edge while pressing the center hole lightly.
- Do not touch the shiny surface of the disc, or bend the disc.
- Put the disc back in its case after use to prevent warping.

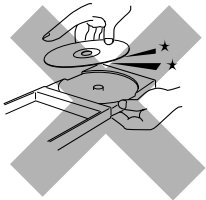

- Be careful not to scratch the surface of the disc when placing it back in its case.
- Avoid exposure to direct sunlight, temperature extremes, and moisture.



To clean the disc

Wipe the disc with a soft cloth in a straight line from center to edge.

Handling cassette tapes

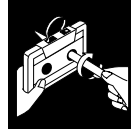

- If the tape is loose in its cassette, take up the slack by inserting a pencil in one of the reels and rotating.
- If the tape is loose, it may get stretched, cut, or caught in the cassette.



- Be careful not to touch the tape surface.



- Avoid the following places to store the tape:

- In dusty places
- In direct sunlight or heat
- In moist areas
- Near a magnet



DO NOT use any solvent—such as conventional record cleaner, spray, thinner, or benzine—to clean the disc.

Troubleshooting



If you are having a problem with your unit, check this list for a possible solution before calling for service. If you cannot solve the problem from the hints given here, or the unit has been physically damaged, call a qualified person, such as your dealer, for service.

Symptom	Cause	Action
Unable to cancel the display demonstration.	Other buttons are pressed to cancel the display demonstration.	Press DEMO on the unit. (See page 8.)
No sound is heard.	Connections are incorrect or loose.	Check all connections and make corrections. (See pages 6 to 8.)
Hard to listen to broadcasts because of noise.	<ul style="list-style-type: none"> Antennas are disconnected. The AM loop antenna is too close to the unit. The FM antenna is not properly extended and positioned. 	<ul style="list-style-type: none"> Reconnect the antennas correctly and securely. Change the position and direction of the AM loop antenna. Extend the FM antenna at the best position.
The disc sound is discontinuous.	The disc is scratched or dirty.	Clean or replace the disc. (See page 22.)
The disc tray does not open or close.	<ul style="list-style-type: none"> The AC power cord is not plugged in. Trays are locked. 	<ul style="list-style-type: none"> Plug the AC power cord. Unlock the trays. (See page 15.)
The disc does not play.	The disc is placed upside down.	Place the disc with the label side up.
The cassette holders cannot be opened.	Power supply from the AC power cord has been cut off while the tape was running.	Turn on the unit.
Impossible to record.	Small tabs on the back of the cassette are removed.	Cover the holes with adhesive tape.
Operations are disabled.	The built-in microprocessor may malfunction due to external electrical interference.	Unplug the AC power cord and then plug it back in.
Unable to operate the unit from the remote control.	<ul style="list-style-type: none"> The path between the remote control and the remote sensor on the unit is blocked. The batteries are exhausted. 	<ul style="list-style-type: none"> Remove the obstruction. Replace the batteries.

Specifications

Design and specifications are subject to change without notice.

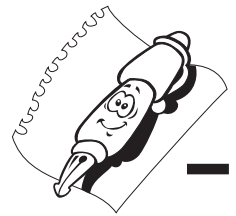

Amplifier section—CA-MXGT700

Output Power

SUBWOOFERS : 110 W per channel, min. RMS, driven into 6 Ω at 63 Hz with no more than 10% total harmonic distortion.

MAIN SPEAKERS: 55 W per channel, min. RMS, driven into 4 Ω at 1 kHz with no more than 10% total harmonic distortion.

Audio input sensitivity/Impedance

(at 1 kHz, measured at MAIN SPEAKERS)

AUX : 400 mV/50 kΩ

Digital output: DIGITAL OUT (OPTICAL)

Signal wave length : 660 nm

Output level : -21 dBm to -15 dBm

Speakers/Impedance : Subwoofers : 6 Ω – 16 Ω
Main speakers : 4 Ω – 8 Ω

Tuner

FM tuning range : 87.50 MHz – 108.00 MHz

AM tuning range : 530 kHz – 1 710 kHz

CD player

CD Capacity : 3 CDs

Dynamic range : 85 dB

Signal-to-noise ratio : 85 dB

Cassette deck

Frequency response

Normal (type I): 50 Hz — 14 000 Hz

Wow and flutter : 0.15% (WRMS)

General

Power requirement : AC 120 V[~], 60 Hz

Power consumption : 145 W / 200 VA (at operation)
19 W (on standby)

Dimensions (approx.): 270 mm x 317 mm x 449 mm (W/H/D)
(10^{11/16} in. x 12^{1/2} in. x 17^{11/16} in.)

Mass (approx.) : 9.1 kg (20.1 lbs)

Supplied accessories

See page 6.

Speaker section—SP-MXGT700

Type : 3-way bass-reflex type

Speaker units : Subwoofer : 20 cm (7^{7/8} in.)
cone x1
Main Woofer : 9 cm (3^{8/16} in.) cone x1
Tweeter : 5 cm (2 in.) cone x1

Power handling capacity : Subwoofer : 110 W
Main speaker : 55 W

Impedance : Subwoofer : 6 Ω
Main speaker : 4 Ω

Frequency range : Subwoofer : 26 Hz — 92 Hz
Main speaker : 92 Hz — 20 000 Hz

Sound pressure level : Subwoofer : 75 dB/W•m
Main speaker : 88 dB/W•m

Dimensions (approx.) : 240 mm x 425 mm x 333 mm (W/H/D)
(9^{1/2} in. x 16^{3/4} in. x 13^{1/8} in.)

Mass (approx.) : 5.4 kg (12.0 lbs) each

Amplifier section—CA-MXG500

Output Power

SUBWOOFERS : 80 W per channel, min. RMS, driven into 6 Ω at 63 Hz with no more than 10% total harmonic distortion.

MAIN SPEAKERS: 40 W per channel, min. RMS, driven into 4 Ω at 1 kHz with no more than 10% total harmonic distortion.

Audio input sensitivity/Impedance

(at 1 kHz, measured at MAIN SPEAKERS)

AUX : 400 mV/50 kΩ

Digital output: DIGITAL OUT (OPTICAL)

Signal wave length : 660 nm

Output level : -21 dBm to -15 dBm

Speakers/Impedance : Subwoofers : 6 Ω – 16 Ω
Main speakers : 4 Ω – 8 Ω

Tuner

FM tuning range : 87.50 MHz – 108.00 MHz

AM tuning range : 530 kHz – 1 710 kHz

CD player

CD Capacity : 3 CDs

Dynamic range : 85 dB

Signal-to-noise ratio : 85 dB

Cassette deck

Frequency response

Normal (type I): 50 Hz — 14 000 Hz

Wow and flutter : 0.15% (WRMS)

General

Power requirement : AC 120 V[~], 60 Hz

Power consumption : 130 W / 200 VA (at operation)
17 W (on standby)

Dimensions (approx.): 270 mm x 317 mm x 449 mm (W/H/D)
(10^{11/16} in. x 12^{1/2} in. x 17^{11/16} in.)

Mass (approx.) : 8.8 kg (19.4 lbs)

Supplied accessories

See page 6.

Speaker section—SP-MXG500

Type : 3-way bass-reflex type

Speaker units : Subwoofer : 13.5 cm (5^{3/8} in.)
cone x1
Main Woofer : 13.5 cm (5^{3/8} in.)
cone x1
Tweeter : 5 cm (2 in.) cone x1

Power handling capacity : Subwoofer : 80 W
Main speaker : 40 W

Impedance : Subwoofer : 6 Ω
Main speaker: 4 Ω

Frequency range : Subwoofer : 26 Hz — 92 Hz
Main speaker : 92 Hz — 20 000 Hz

Sound pressure level : Subwoofer : 75 dB/W•m
Main speaker : 88 dB/W•m

Dimensions (approx.) : 282 mm x 318 mm x 322 mm (W/H/D)
(11^{1/8} in. x 12^{9/16} in. x 12^{11/16} in.)

Mass (approx.) : 5.0 kg (11.1 lbs) each

Authorized Service Centers

QUALITY **JVC**[®] SERVICE

HOW TO LOCATE YOUR JVC SERVICE CENTER

TOLL FREE: 1 (800) 537-5722

<http://www.jvc.com>

Dear Customer,

In order to receive the most satisfaction from your purchase, please read the instruction booklet before operating the unit. In the event that repairs are necessary, please call 1 (800)537-5722 for your nearest authorized servicer or visit our website at **www.JVC.com**

Remember to retain your Bill of Sale for Warranty Service.

Do not service the television yourself

Caution

To prevent electrical shock, do not open the cabinet. There are no user serviceable parts inside. Please refer to qualified service personnel for repairs.

Accessories

To purchase accessories for your JVC product, please call toll free: 1 (800)882-2345 or on the web at **www.JVC.com**



LIMITED WARRANTY

AUDIO-1

JVC COMPANY OF AMERICA warrants this product and all parts thereof, except as set forth below ONLY TO THE ORIGINAL PURCHASER AT RETAIL to be FREE FROM DEFECTIVE MATERIALS AND WORKMANSHIP from the date of original retail purchase for the period as shown below. ("The Warranty Period")

PARTS	1 YR	LABOR	1 YR
-------	-------------	-------	-------------

THIS LIMITED WARRANTY IS VALID ONLY IN THE FIFTY (50) UNITED STATES, THE DISTRICT OF COLUMBIA AND IN COMMONWEALTH OF PUERTO RICO.

WHAT WE WILL DO:

If this product is found to be defective, JVC will repair or replace defective parts at no charge to the original owner. Such repair and replacement services shall be rendered by JVC during normal business hours at JVC authorized service centers. Parts used for replacement are warranted only for the remainder of the Warranty Period. All products and parts thereof may be brought to a JVC authorized service center on a carry-in basis except for Television sets having a screen size 25 inches and above which are covered on an in-home basis.

WHAT YOU MUST DO FOR WARRANTY SERVICE:

Return your product to a JVC authorized service center with a copy of your bill of sale. For your nearest JVC authorized service center, please call toll free: (800) 537-5722.

If service is not available locally, box the product carefully, preferably in the original carton, and ship, insured, with a copy of your bill of sale plus a letter of explanation of the problem to the nearest JVC Factory Service Center, the name and location of which will be given to you by the toll-free number.

If you have any questions concerning your JVC Product, please contact our Customer Relations Department.

WHAT IS NOT COVERED:

This limited warranty provided by JVC does not cover:

1. Products which have been subject to abuse, accident, alteration, modification, tampering, negligence, misuse, faulty installation, lack of reasonable care, or if repaired or serviced by anyone other than a service facility authorized by JVC to render such service, or if affixed to any attachment not provided with the products, or if the model number or serial number has been altered, tampered with, defaced or removed;
2. Initial installation and installation and removal for repair;
3. Operational adjustments covered in the Owner's Manual, normal maintenance, video and audio head cleaning;
4. Damage that occurs in shipment, due to act of God, and cosmetic damage;
5. Signal reception problems and failures due to line power surge;
6. Video Pick-up Tubes/CCD Image Sensor, Cartridge, Stylus (Needle) are covered for 90 days from the date of purchase;
7. Accessories
8. Batteries (except that Rechargeable Batteries are covered for 90 days from the date of purchase);

There are no express warranties except as listed above.

THE DURATION OF ANY IMPLIED WARRANTIES, INCLUDING THE IMPLIED WARRANTY OF MERCHANTABILITY, IS LIMITED TO THE DURATION OF THE EXPRESS WARRANTY HEREIN.

JVC SHALL NOT BE LIABLE FOR THE LOSS OF USE OF THE PRODUCT, INCONVENIENCE, LOSS OR ANY OTHER DAMAGES, WHETHER DIRECT, INCIDENTAL OR CONSEQUENTIAL (INCLUDING, WITHOUT LIMITATION, DAMAGE TO TAPES, RECORDS OR DISCS) RESULTING FROM THE USE OF THIS PRODUCT, OR ARISING OUT OF ANY BREACH OF THIS WARRANTY. ALL EXPRESS AND IMPLIED WARRANTIES, INCLUDING THE WARRANTIES OF MERCHANTABILITY AND FITNESS FOR PARTICULAR PURPOSE, ARE LIMITED TO THE WARRANTY PERIOD SET FORTH ABOVE.

Some states do not allow the exclusion of incidental or consequential damages or limitations on how long an implied warranty lasts, so these limitations or exclusions may not apply to you. This warranty gives you specific legal rights and you may also have other rights which vary from state to state.

JVC COMPANY OF AMERICA 1700 Valley Road
 DIVISION OF JVC AMERICAS CORP. Wayne, NJ 07470

REFURBISHED PRODUCTS CARRY A SEPARATE WARRANTY, THIS WARRANTY DOES NOT APPLY. FOR DETAILS OF REFURBISHED PRODUCT WARRANTY, PLEASE REFER TO THE REFURBISHED PRODUCT WARRANTY INFORMATION PACKAGED WITH EACH REFURBISHED PRODUCT.

For customer use:

Enter below the Model No. which is located either on the rear, bottom or side of the cabinet. Retain this information for future reference.

Model No. : _____ Serial No. : _____

Purchase data : _____ Name of dealer : _____

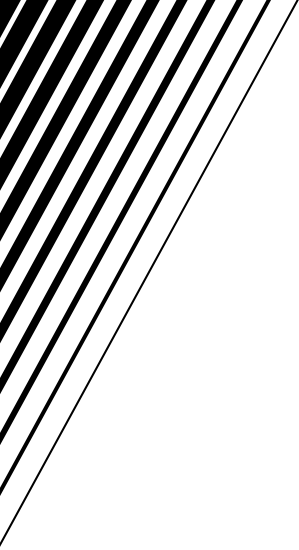

JVC
VICTOR COMPANY OF JAPAN, LIMITED

JVC



COMPACT COMPONENT SYSTEM

SYSTEME DE COMPOSANTS COMPACT

MX-GT700 — Consists of CA-MXGT700 and SP-MXGT700.
— Composé du CA-MXGT700 et SP-MXGT700.

MX-G500 — Consists of CA-MXG500 and SP-MXG500.
— Composé du CA-MXG500 et SP-MXG500.

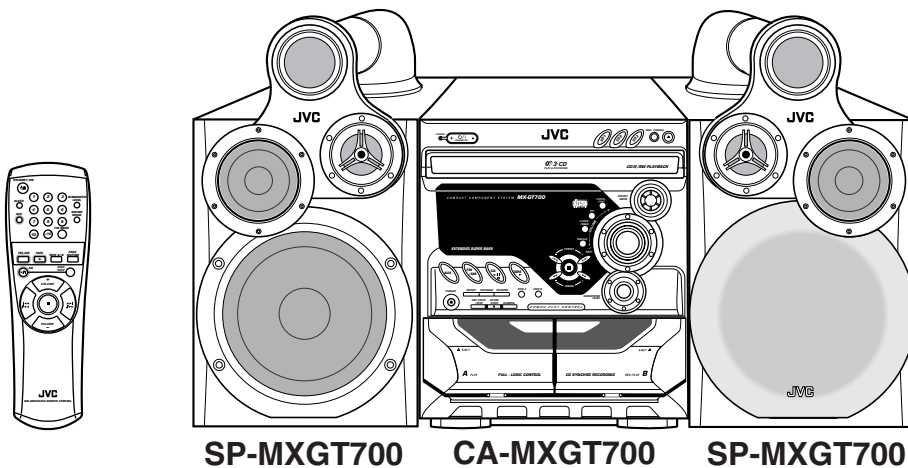

SP-MXGT700

CA-MXGT700

SP-MXGT700

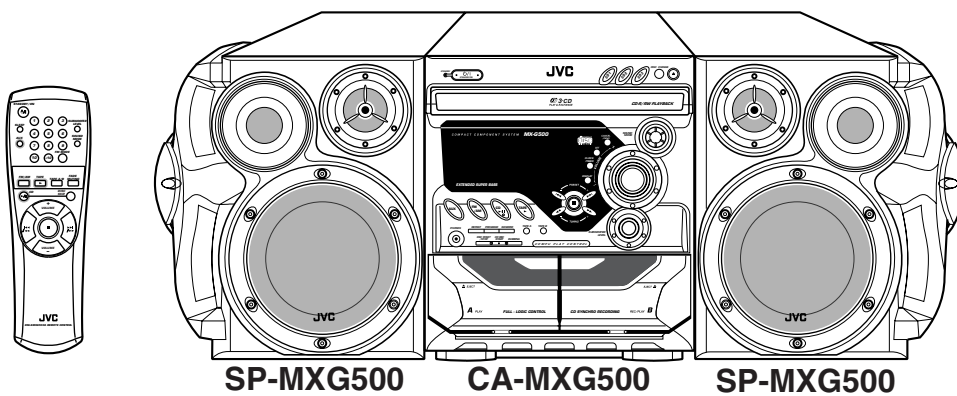

SP-MXG500

CA-MXG500

SP-MXG500

INSTRUCTIONS MANUEL D'INSTRUCTIONS

For Customer Use:

Enter below the Model No. and Serial No. which are located either on the rear, bottom or side of the cabinet. Retain this information for future reference.

Model No. _____

Serial No. _____

LVT0901-002A

[C]

Warnings, Cautions and Others

Mises en garde, précautions et indications diverses



The lightning flash with arrowhead symbol, within an equilateral triangle is intended to alert the user to the presence of uninsulated "dangerous voltage" within the product's enclosure that may be of sufficient magnitude to constitute a risk of electric shock to persons.



The exclamation point within an equilateral triangle is intended to alert the user to the presence of important operating and maintenance (servicing) instructions in the literature accompanying the appliance.

WARNING: TO REDUCE THE RISK OF FIRE OR ELECTRIC SHOCK, DO NOT EXPOSE THIS APPLIANCE TO RAIN OR MOISTURE.

For U.S.A.

This equipment has been tested and found to comply with the limits for a Class B digital device, pursuant to part 15 of the FCC Rules. These limits are designed to provide reasonable protection against harmful interference in a residential installation.

This equipment generates, uses and can radiate radio frequency energy and, if not installed and used in accordance with the instructions, may cause harmful interference to radio communications. However, there is no guarantee that interference will not occur in a particular installation. If this equipment does cause harmful interference to radio or television reception, which can be determined by turning the equipment off and on, the user is encouraged to try to correct the interference by one or more of the following measures:

Reorient or relocate the receiving antenna.
Increase the separation between the equipment and receiver.
Connect the equipment into an outlet on a circuit different from that to which the receiver is connected.
Consult the dealer or an experienced radio/TV technician for help.

CAUTION

To reduce the risk of electrical shocks, fire, etc.:

1. Do not remove screws, covers or cabinet.
2. Do not expose this appliance to rain or moisture.

ATTENTION

Afin d'éviter tout risque d'électrocution, d'incendie, etc.:

1. Ne pas enlever les vis ni les panneaux et ne pas ouvrir le coffret de l'appareil.
2. Ne pas exposer l'appareil à la pluie ni à l'humidité.

Caution — STANDBY/ON switch!

Disconnect the mains plug to shut the power off completely. The  STANDBY/ON switch in any position does not disconnect the mains line. The power can be remote controlled.

Attention — Commutateur STANDBY/ON!

Déconnecter la fiche de secteur pour couper complètement le courant. Le commutateur  STANDBY/ON ne coupe jamais complètement la ligne de secteur, quelle que soit sa position. Le courant peut être télécommandé.

1. CLASS 1 LASER PRODUCT
2. **CAUTION:** Invisible laser radiation when open and interlock failed or defeated. Avoid direct exposure to beam.
3. **CAUTION:** Do not open the top cover. There are no user serviceable parts inside the Unit; leave all servicing to qualified service personnel.

1. PRODUIT LASER CLASSE 1
2. **ATTENTION:** Radiation laser invisible quand l'appareil est ouvert ou que le verrouillage est en panne ou désactivé. Éviter une exposition directe au rayon.
3. **ATTENTION:** Ne pas ouvrir le couvercle du dessus. Il n'y a aucune pièce utilisable à l'intérieur. Laisser à un personnel qualifié le soin de réparer votre appareil.

For Canada/pour le Canada

CAUTION: TO PREVENT ELECTRIC SHOCK, MATCH WIDE BLADE OF PLUG TO WIDE SLOT, FULLY INSERT.

ATTENTION: POUR EVITER LES CHOCS ELECTRIQUES, INTRODUIRE LA LAME LA PLUS LARGE DE LA FICHE DANS LA BORNE CORRESPONDANTE DE LA PRISE ET POUSSER JUSQU'AU FOND.

For Canada/pour le Canada

THIS DIGITAL APPARATUS DOES NOT EXCEED THE CLASS B LIMITS FOR RADIO NOISE EMISSIONS FROM DIGITAL APPARATUS AS SET OUT IN THE INTERFERENCE-CAUSING EQUIPMENT STANDARD ENTITLED "DIGITAL APPARATUS," ICES-003 OF THE DEPARTMENT OF COMMUNICATIONS.

CET APPAREIL NUMERIQUE RESPECTE LES LIMITES DE BRUITS RADIOELECTRIQUES APPLICABLES AUX APPAREILS NUMIRIQUES DE CLASSE B PRESCRITES DANS LA NORME SUR LE MATERIEL BROUILLEUR: "APPAREILS NUMERIQUES", NMB-003 EDICTEE PAR LE MINISTRE DES COMMUNICATIONS.

Caution: Proper Ventilation

To avoid risk of electric shock and fire, and to prevent damage, locate the apparatus as follows:

1 Front:

No obstructions and open spacing.

2 Sides/ Top/ Back:

No obstructions should be placed in the areas shown by the dimensions below.

3 Bottom:

Place on the level surface. Maintain an adequate air path for ventilation by placing on a stand with a height of 10 cm or more.

Attention: Aération correcte

Pour prévenir tout risque de décharge électrique ou d'incendie et éviter toute détérioration, installez l'appareil de la manière suivante:

1 Avant:

Bien dégagé de tout objet.

2 Côtés/dessus/dessous:

Assurez-vous que rien ne bloque les espaces indiqués sur le schéma ci-dessous.

3 Dessous:

Posez l'appareil sur une surface plane et horizontale. Veillez à ce que sa ventilation correcte puisse se faire en le plaçant sur un support d'au moins dix centimètres de hauteur.

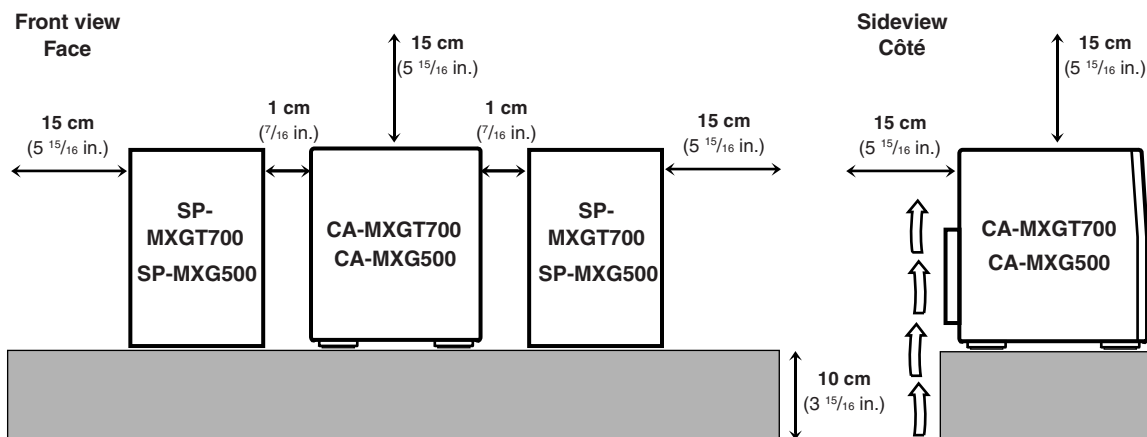

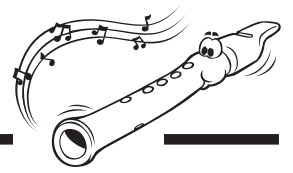

Introduction

We would like to thank you for purchasing one of our JVC products. Before operating this unit, read this manual carefully and thoroughly to obtain the best possible performance from your unit, and retain this manual for future reference.

About This Manual

This manual is organized as follows:

- The manual mainly explains operations using the buttons and controls on the unit. You can also use the buttons on the remote control if they have the same or similar names (or marks) as those on the unit. If operation using the remote control is different from that using the unit, it is then explained.
- Basic and common information that is the same for many functions is grouped in one place, and is not repeated in each procedure. For instance, we do not repeat the information about turning on/off the unit, setting the volume, changing the sound effects, and others, which are explained in the section “Common Operations” on pages 9 and 10.
- The following marks are used in this manual:



Gives you warnings and cautions to prevent damage or risk of fire/electric shock. Also gives you information which is not good for obtaining the best possible performance from the unit.



Gives you information and hints you had better know.

Precautions

Installation

- Install in a place which is level, dry and neither too hot nor too cold—between 5°C (41°F) and 35°C (95°F).
- Install the unit in a location with adequate ventilation to prevent internal heat built-up in the unit.
- Leave sufficient distance between the unit and the TV.
- Keep the speakers away from the TV to avoid interference with TV.



DO NOT install the unit in a location near heat sources, or in a place subject to direct sunlight, excessive dust or vibration.

Power sources

- When unplugging from the wall outlet, always pull the plug, not the AC power cord.



DO NOT handle the AC power cord with wet hands.

Moisture condensation

Moisture may condense on the lens inside the unit in the following cases:

- After starting heating in the room
 - In a damp room
 - If the unit is brought directly from a cold to a warm place
- Should this occur, the unit may malfunction. In this case, leave the unit turned on for a few hours until the moisture evaporates, unplug the AC power cord, and then plug it in again.

Others

- Should any metallic object or liquid fall into the unit, unplug the unit and consult your dealer before operating any further.
- If you are not going to operate the unit for an extended period of time, unplug the AC power cord from the wall outlet.



DO NOT disassemble the unit since there are no user serviceable parts inside.

If anything goes wrong, unplug the AC power cord and consult your dealer.

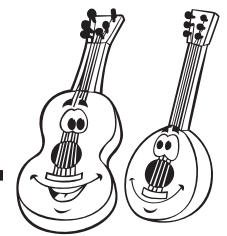

Location of the Buttons and Controls	3
Front Panel	3
Remote Control	5
Getting Started	6
Unpacking	6
Putting the Batteries into the Remote Control	6
Connecting Antennas	6
Connecting Speakers	7
Connecting Other Equipment	8
Canceling the Display Demonstration	8
Common Operations	9
Turning On or Off the Power	9
Setting the Clock	9
Selecting the Sources	9
Adjusting the Volume	10
Reinforcing the Bass Sound	10
Selecting the Sound Modes	10
Listening to the Radio	11
Tuning in a Station	11
Presetting Stations	11
Tuning in a Preset Station	11
Playing Back CDs	12
Loading CDs	12
Playing Back CDs—All Disc and One Disc	12
Basic CD Operations	13
Programing the Playing Order of the Tracks	
—Program Play	14
Playing at Random—Random Play	15
Repeating Tracks or CDs—Repeat Play	15
Prohibiting Disc Ejection—Tray Lock	15
Playing Back Tapes	16
Playing Back a Tape	16
Recording	17
Recording a Tape on Deck B	17
Dubbing Tapes	18
CD Synchronized Recording	18
Using the Timers	19
Using Daily Timer	19
Using Recording Timer	20
Using Sleep Timer	21
Timer Priority	21
Maintenance	22
Troubleshooting	23
Specifications	24

Location of the Buttons and Controls

Become familiar with the buttons and controls on your unit.

Front Panel

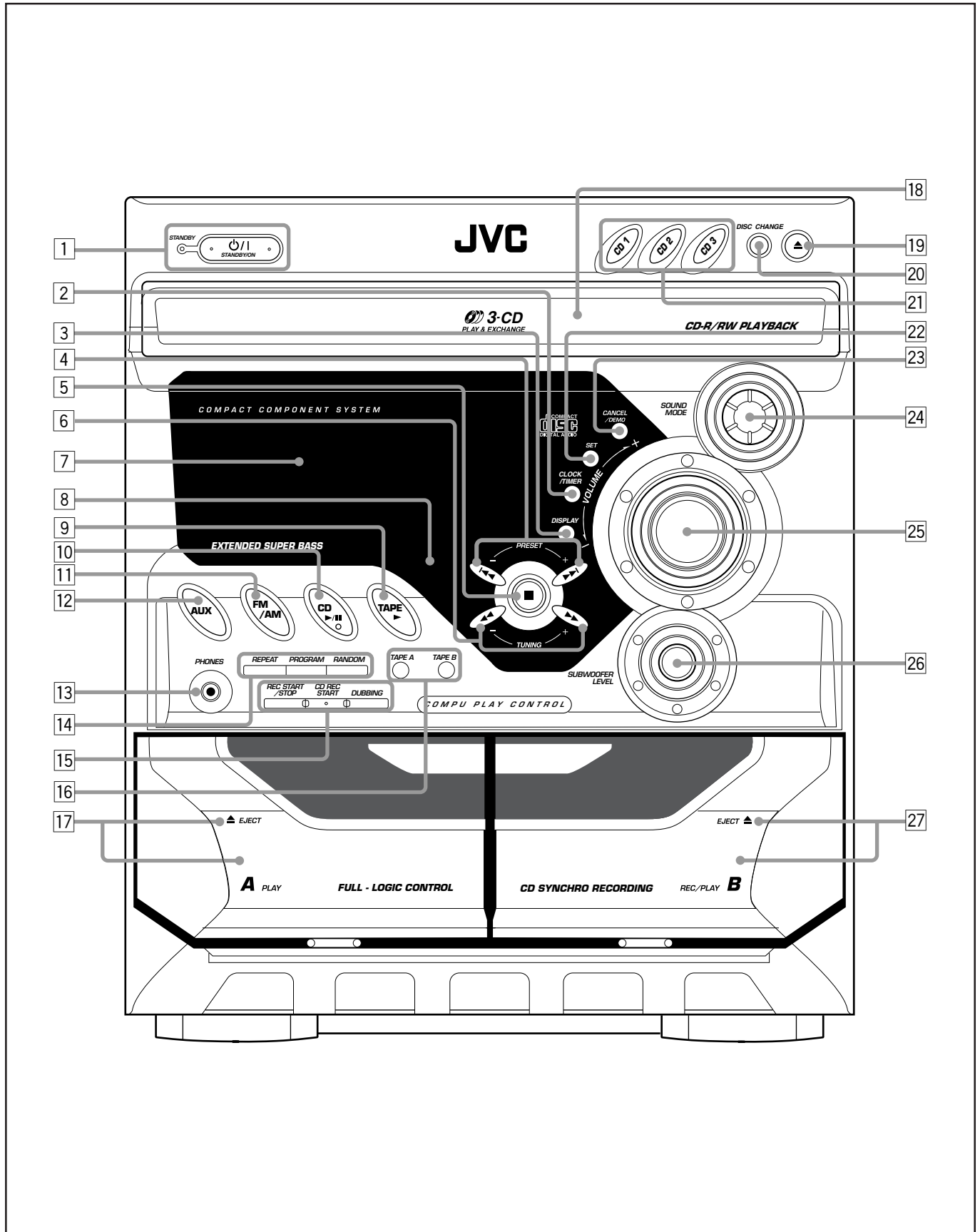

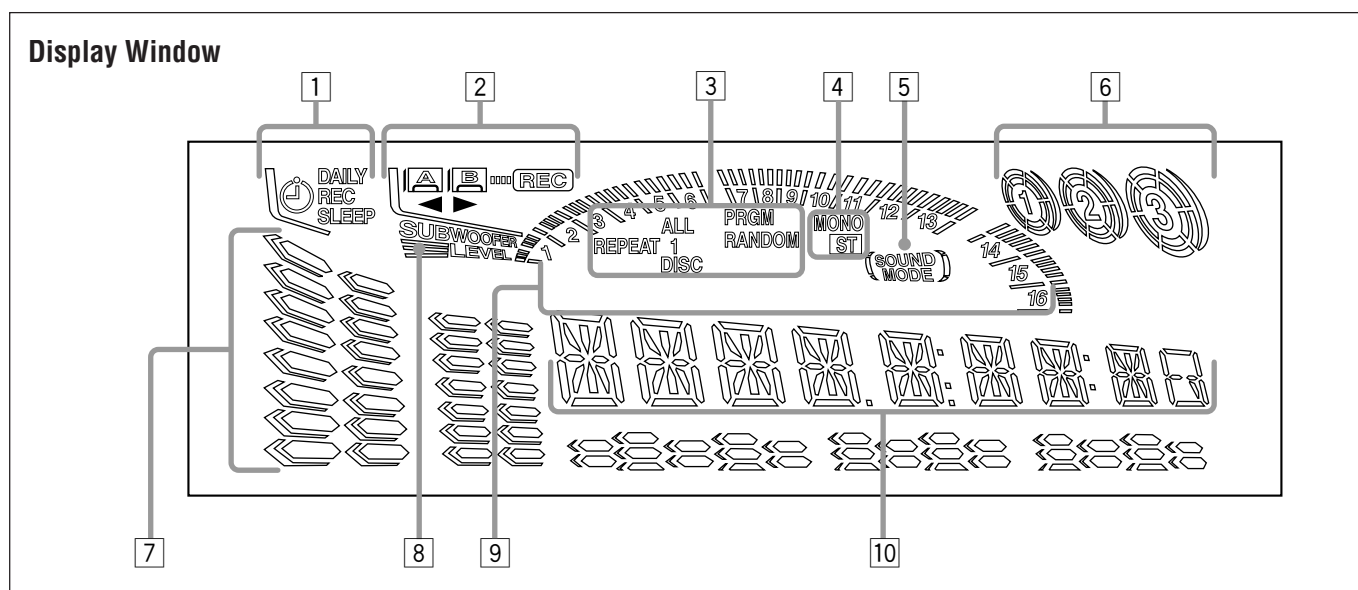

See pages in the parentheses for details.

Front Panel

- 1 **⏻/⏻** STANDBY/ON button and STANDBY lamp (9)
- 2 **CLOCK/TIMER** button (9, 19 – 21)
- 3 **DISPLAY** button (9)
- 4 **PRESET +/-** buttons (11)
◀◀ / ▶▶ (reverse search/forward search) buttons (9, 13 – 15, 19 – 21)
- 5 **■** (stop) button (12 – 18)
- 6 **TUNING +/-** buttons (11)
◀◀ / ▶▶ (fast rewind/fast forward) buttons (13, 16)
- 7 Display window
- 8 Remote sensor
- 9 **TAPE ▶** button and lamp (9, 16, 18)
Pressing this button also turns on the unit.
- 10 **CD ▶/||** (play/pause) button and lamp (9, 12 – 15)
Pressing this button also turns on the unit.
- 11 **FM/AM** button and lamp (9, 11)
Pressing this button also turns on the unit.
- 12 **AUX** button and lamp (9)
Pressing this button also turns on the unit.
- 13 **PHONES** jack (10)
- 14 **REPEAT** button (12, 13, 15)
PROGRAM button (14)
RANDOM button (15)
- 15 **REC START/STOP** button (17)
CD REC START button (18)
DUBBING button (18)
- 16 **TAPE A** button (16)
TAPE B button (16)
- 17 **Deck A** cassette holder (16, 18)
Pressing the ▲ EJECT portion opens the holder.
- 18 **Carrousel**
- 19 **▲** (Carrousel open/close) button (12 – 15)
Pressing this button also turns on the unit.
- 20 **DISC CHANGE** button (12, 13)

- 21 **Disc number buttons and lamps** (CD1, CD2, and CD3) (13 – 15, 18)

Pressing one of these buttons also turns on the unit.

- 22 **SET** button (9, 11, 14, 19 – 21)
- 23 **CANCEL/DEMO** button (8, 9, 14, 20, 21)
- 24 **SOUND MODE** control (10)
- 25 **VOLUME** control (10)
- 26 **SUBWOOFER LEVEL** control (10)
- 27 **Deck B** cassette holder (16 – 18)

Pressing the EJECT ▲ portion opens the holder.

Display window

- 1 **Timer indicators**
 - **DAILY** (daily timer), **REC** (recording timer), **SLEEP** (sleep timer), and **⌚** (timer) indicators
- 2 **Tape operation indicators**
 - **A/B** (operating deck), **REC** (recording), and **◀▶** (tape running) indicators
- 3 **CD play mode indicators**
 - **REPEAT** (1, 1 DISC, ALL DISC), **PRGM** (program), and **RANDOM** indicators
- 4 **Tuner operation indicators**
 - **MONO** and **ST** (stereo) indicators
- 5 **SOUND MODE** indicator
- 6 **Disc indicators**
- 7 **Volume level, Subwoofer level and Sound Mode pattern indicators**
- 8 **SUBWOOFER LEVEL** indicator
- 9 **CD track number indicators**
- 10 **Main display**
 - Shows the source name, frequency, etc.



Remote Control

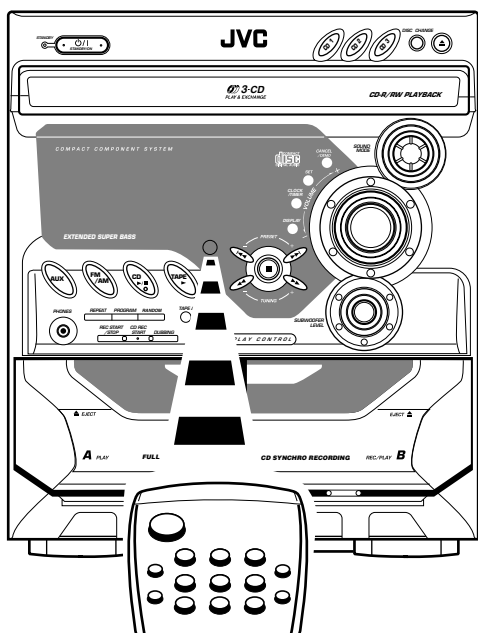
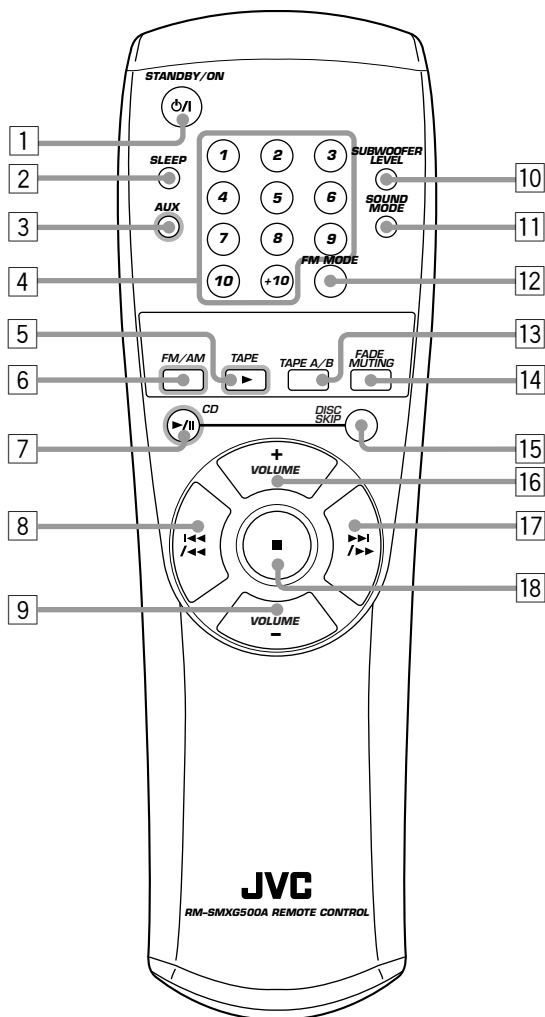

When using the remote control, point it at the remote sensor on the front panel.

Remote Control

- 1 STANDBY/ON button (9)
- 2 SLEEP button (21)
- 3 AUX button (9)
Pressing this button also turns on the unit.
- 4 Number buttons (11, 13)
- 5 TAPE button (9, 16)
Pressing this button also turns on the unit.
- 6 FM/AM button (9, 11)
Pressing this button also turns on the unit.
- 7 CD button (9, 12 – 15)
Pressing this button also turns on the unit.
- 8 (fast rewind/reverse search) button (11, 13, 16)
- 9 VOLUME – button (10)
- 10 SUBWOOFER LEVEL button (10)
- 11 SOUND MODE button (10)
- 12 FM MODE button (11)
- 13 TAPE A/B button (16)
- 14 FADE MUTING button (10)
- 15 DISC SKIP button (12, 13)
- 16 VOLUME + button (10)
- 17 (fast forward/forward search) button (11, 13, 16)
- 18 (stop) button (12 – 18)

Unpacking

After unpacking, check to be sure that you have all the following items.

The number in the parentheses indicates the quantity of the pieces supplied.

- AM loop antenna (1)
- FM antenna (1)
- Remote control (1)
- Batteries (2)

If any is missing, consult your dealer immediately.

Putting the Batteries into the Remote Control

Insert the batteries—UM-4/AAA/IEC R03—into the remote control, by matching the polarity (+ and –) on the batteries with the + and – markings on the battery compartment. When the remote control can no longer operate the unit, replace both batteries at the same time.

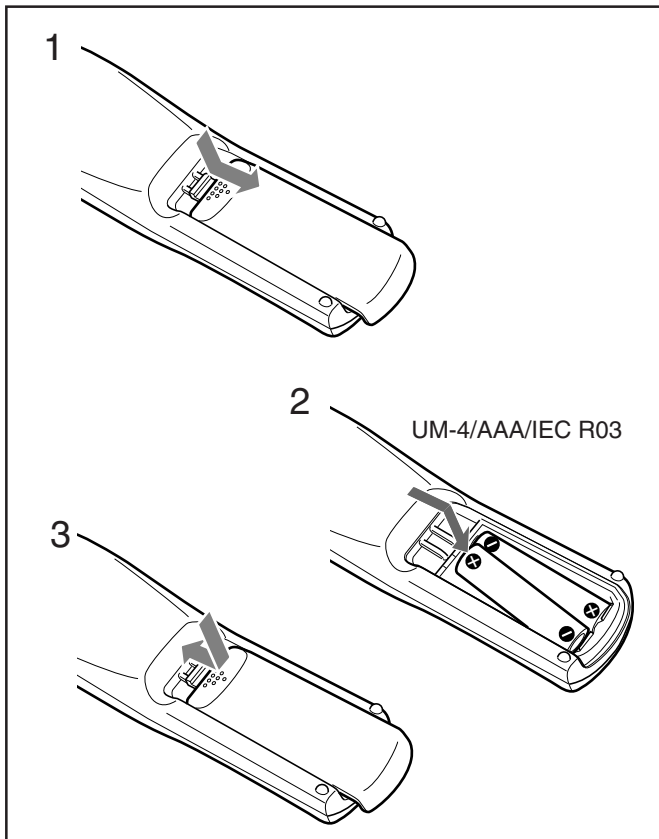

- DO NOT use an old battery together with a new one.
- DO NOT use different types of batteries together.
- DO NOT expose batteries to heat or flame.
- DO NOT leave the batteries in the battery compartment when you are not going to use the remote control for an extended period of time. Otherwise, it will be damaged from battery leakage.

Connecting Antennas

FM antenna

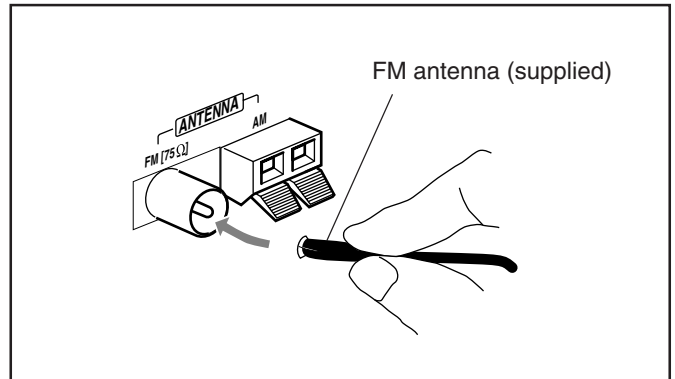

- 1 Attach the FM antenna to the FM [75 Ω] coaxial terminal.**
- 2 Extend the FM antenna.**
- 3 Fasten it up in the position which gives you the best reception, then fix it on the wall, etc.**



About the supplied FM antenna

The FM antenna supplied with this unit can be used as temporary measure. If reception is poor, you can connect an outdoor FM antenna.

To connect an outdoor FM antenna

Before connecting it, disconnect the supplied FM antenna.

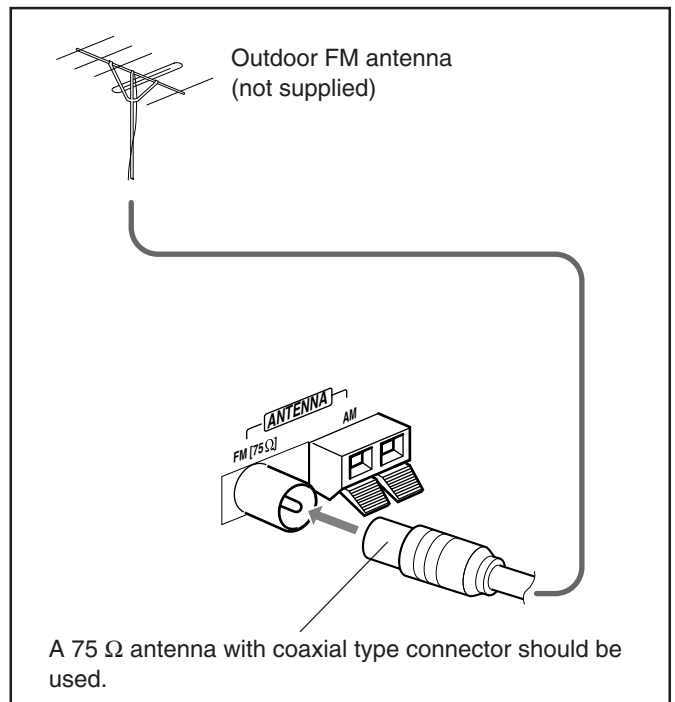

AM antenna

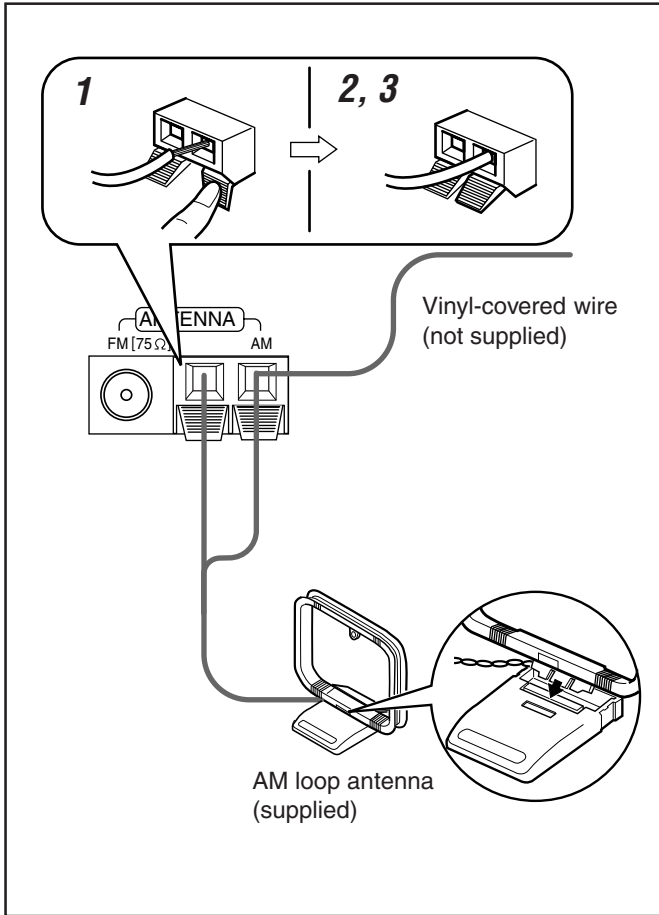

- 1 Press and hold the clamp of the AM terminal on the rear of the unit.**
- 2 Insert the end of the AM loop antenna cord into the terminal.**
 - If the AM loop antenna wire is covered with vinyl, remove the vinyl by twisting it as shown in the diagram.
- 3 Release the finger from the clamp.**
- 4 Turn the AM loop antenna until you have the best reception.**

To connect an outdoor AM antenna

When reception is poor, connect a single vinyl-covered wire to the AM terminal and extend it horizontally. (The AM loop antenna must remain connected.)



For better reception of both FM and AM

- Make sure the antenna conductors do not touch any other terminals and connecting cords.
- Keep the antennas away from metallic parts of the unit, connecting cords, and the AC power cord.

Connecting Speakers



For MX-GT700:
DO NOT carry the speaker by holding the duct tube (on the top of the speaker).

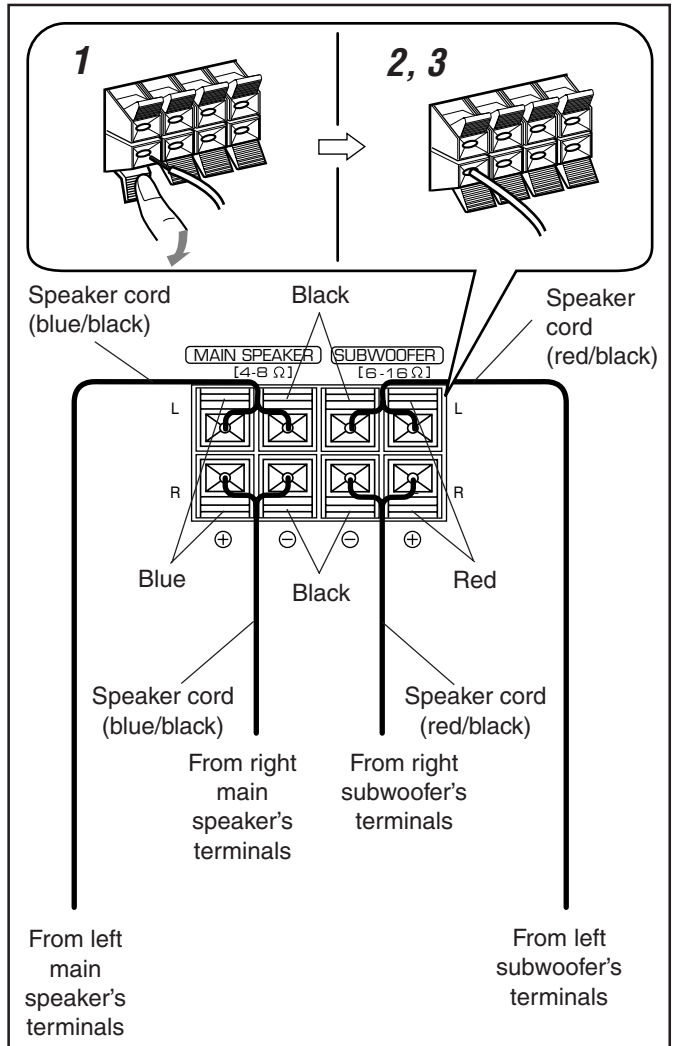

- 1 Press and hold the clamp of the speaker terminal on the rear of the unit.**
- 2 Insert the end of the speaker cord into the terminal.**

Match the polarity (colors): Blue (+) to blue (+) and black (-) to black (-); red (+) to red (+) and black (-) to black (-).

 - If the wire is covered with vinyl, remove the vinyl by twisting it as shown in the diagram.
- 3 Release the finger from the clamp.**

IMPORTANT:

- Use only speakers with the same speaker impedance as indicated by the speaker terminals on the rear of the unit.
- DO NOT connect more than one speaker to one speaker terminal.



For MX-GT700:

To remove the speaker grilles

The speaker grilles are removable as the illustration below.

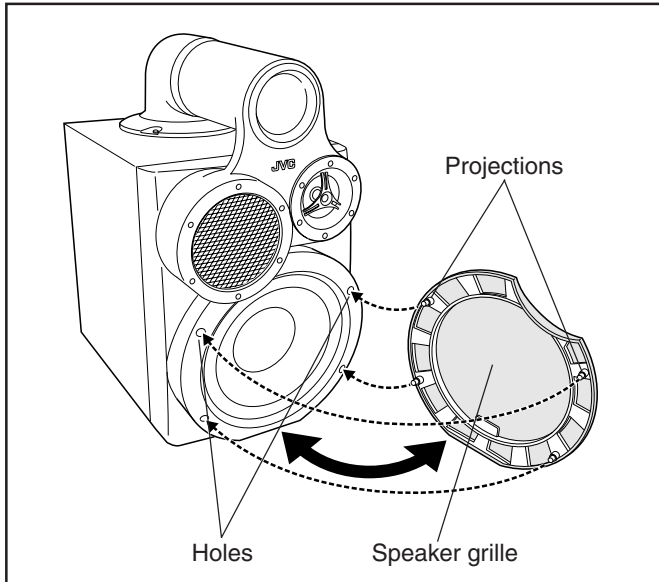

To remove the speaker grille, insert your fingers around the projection at the top of the speaker grille, then pull gently towards you by holding the side. Do the same for the rest of the projections each at a time.

To attach the speaker grille, put the projections of the speaker grille into the holes of the speaker.

Connecting Other Equipment

You can connect both analog and digital equipment.

 • DO NOT connect any equipment while the power is on.
 • DO NOT plug in any equipment until all connections are complete.

To connect an analog component

Be sure that the plugs of the audio cords are color coded: White plugs and jacks are for left audio signals, and red ones for right audio signals.

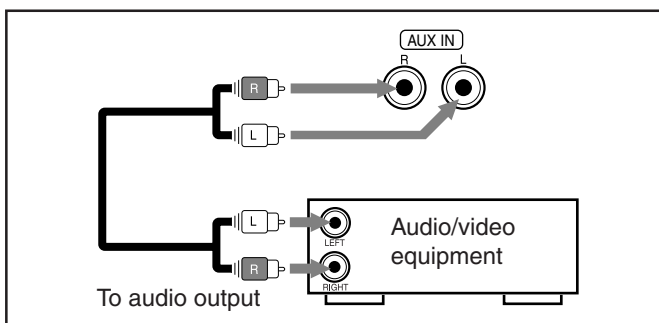

For playing the other equipment through this unit, connect between the audio output jacks on the other equipment and AUX IN jacks by using audio cords (not supplied).

To connect audio equipment with an optical digital input terminal

You can record CD sound onto the connected digital equipment.

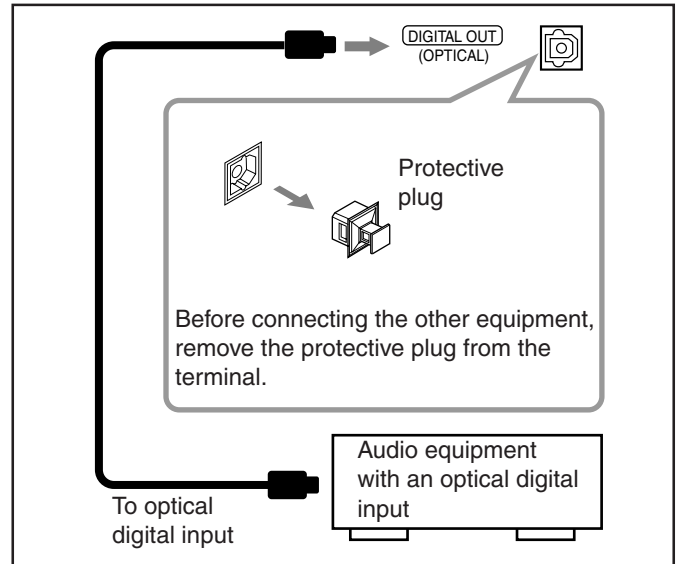

Connect an optical digital cord (not supplied) between the optical digital input terminal on the other equipment and the DIGITAL OUT [OPTICAL] terminal.

NOW, you can plug in the unit and other connected equipment FINALLY!

Canceling the Display Demonstration

When connecting the AC power cord into a wall outlet, the unit automatically starts display demonstration.

On the unit ONLY:

To cancel the display demonstration, press CANCEL/DEMO.



When you press other buttons

The display demonstration stops temporarily. It will start automatically again (if no operation is done for 2 minutes) until you cancel it by pressing CANCEL/DEMO.

To start the display demonstration manually

Press and hold CANCEL/DEMO again for more than 2 seconds.



Common Operations

Turning On or Off the Power

To turn on the unit, press  STANDBY/ON so that the STANDBY lamp goes off.

WELCOME

To turn off the unit (on standby), press  STANDBY/ON again so that the STANDBY lamp lights up.

GOOD BYE

A little power is always consumed even while the unit is on standby.

To switch off the power supply completely, unplug the AC power cord from the AC outlet.



When you unplug the AC power cord or if a power failure occurs

The clock is reset to “-- : --” soon, while the tuner preset stations (see page 11) will be erased in a few days.

Setting the Clock

Before operating the unit any further, first set the clock built in this unit. You can set the clock whether the unit is on or off.

On the unit ONLY:

1 Press CLOCK/TIMER.

FM 12:00

The hour digits start flashing on the display.

2 Press  or  to adjust the hour, then press SET.

FM 5:00

The minute digits start flashing on the display.

- If you want to correct the hour after pressing SET, press CANCEL/DEMO. The hour digits start flashing again.

3 Press  or  to adjust the minute, then press SET.

CLOCK OK

To check the clock time

Press DISPLAY while playing any source.

- Each time you press the button, the source indication and the clock time alternate on the display.

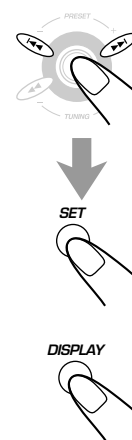

To adjust the clock again

If you have adjusted the clock before, you need to press CLOCK/TIMER repeatedly until “CLOCK” is selected.

- Each time you press the button, the clock/timer setting modes change as follows:



If there is a power failure

The clock loses the setting and is reset to “-- : --.” You need to set the clock again.

Selecting the Sources



To listen to the radio, press FM/AM. (See page 11.)

To play back CDs, press CD . (See pages 12 – 15.)

To play back tapes, press TAPE . (See page 16.)

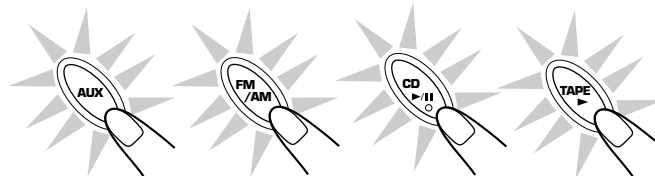
To select the external equipment as the source, press AUX.



When you press the play button for a particular source (AUX, FM/AM, CD , and TAPE ), the unit turns on (and the unit starts playing the source if it is ready—COMPU PLAY CONTROL).

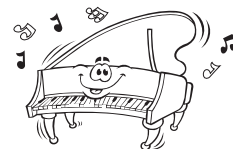

Adjusting the Volume

You can adjust the volume level only while the unit is turned on.

Turn the **VOLUME** control clockwise to increase the volume or counterclockwise to decrease it.

- The volume level can be adjusted in 32 steps (VOL MIN, VOL 1 — VOL 30, and VOL MAX).

VOL 15

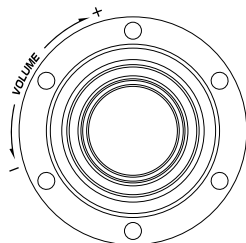

When using the remote control, press **VOLUME +** to increase the volume or press **VOLUME -** to decrease it.



For private listening

Connect a pair of headphones to the **PHONES** jack. No sound comes out of the speakers. Be sure to turn down the volume before connecting or putting on headphones.



DO NOT turn off (on standby) the unit with the volume set to an extremely high level; otherwise, a sudden blast of sound can damage your hearing, speakers and/or headphones when you turn on the unit or start playing any source next time. REMEMBER you cannot adjust the volume level while the unit is on standby.

To turn down the volume level temporarily

Press **FADE MUTING** on the remote control.

The volume level gradually decreases to "VOL MIN."

To restore the sound, press the button again.



Reinforcing the Bass Sound

This function only affects the playback sound, not your recording.

Turn the **SUBWOOFER LEVEL** control clockwise to increase the subwoofer sound or counterclockwise to decrease it.

- The subwoofer level can be adjusted in 4 steps (LEVEL 1 — LEVEL 4.)
- If you turn the control clockwise up to the LEVEL 4, "MAX" flashes on the display for a few seconds.

SUBWOOFER LEVEL indicator always lights up while the unit is on.

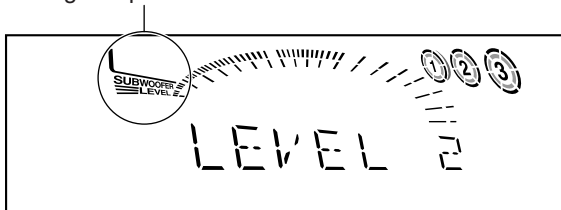

When using the remote control, press **SUBWOOFER LEVEL** to adjust the subwoofer level. Each time you press the button, the subwoofer level changes as LEVEL 1 → LEVEL 2 → LEVEL 3 → LEVEL 4 → (back to the beginning).

Selecting the Sound Modes

This function only affects the playback sound, not your recording.

You can select one of the 6 preset sound modes (3 surround modes and 3 SEA—Sound Effect Amplifier—modes).

To select the sound modes, turn the **SOUND MODE** control until the sound mode you want appears on the display.

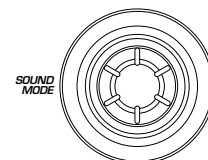

SOUND MODE indicator also lights up on the display



- As you turn the control, the sound modes change as follows:

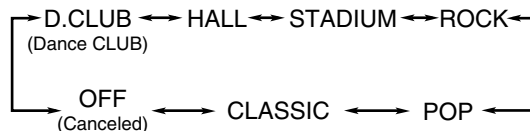

Surround modes*:

D.CLUB : Increases resonance and bass.

HALL : Adds depth and brilliance to the sound.

STADIUM: Adds clarity and spreads the sound, like in an outdoor stadium.

SEA (Sound Effect Amplifier) modes:

ROCK : Boosts low and high frequency. Good for acoustic music.

POP : Good for vocal music.

CLASSIC : Good for classical music.

OFF : Cancels the sound mode.

* Surround elements are added to the SEA elements to create being-there feeling in your room.

When one of these modes is selected, the **SOUND MODE** indicator lights up as — **(SOUND MODE)**

While one of the SEA modes (SEA elements without surround elements) is selected, the **SOUND MODE** indicator lights up as — **SOUND MODE**

When using the remote control, press **SOUND MODE** to select the sound mode.

- Each time you press the button, the sound modes change as follows:

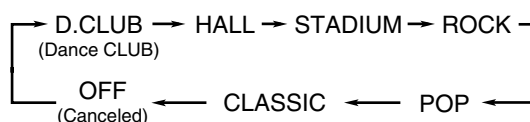



Listening to the Radio

Tuning in a Station

1 Press FM/AM.

The unit automatically turns on and tunes in the previously tuned station (either FM or AM).

- Each time you press the button, the band alternates between FM and AM.



2 Start searching for stations.

On the unit:

Press and hold TUNING + or TUNING – for more than 1 second.

On the remote control:

Press and hold ◀◀/◀◀ or ▶▶/▶▶ for more than 1 second.

The unit starts searching for stations and stops when a station of sufficient signal strength is tuned in.

If a program is broadcast in stereo, the ST (stereo) indicator lights up.

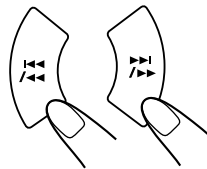
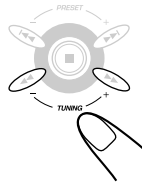

To stop during searching, press TUNING + or TUNING – (or ◀◀/◀◀ or ▶▶/▶▶ on the remote control).



When you press TUNING + or TUNING – (or ◀◀/◀◀ or ▶▶/▶▶ on the remote control) briefly and repeatedly

The frequency changes step by step.

To change the FM reception mode

When an FM stereo broadcast is hard to receive or noisy, press FM MODE on the remote control so that “MONO” appears and MONO indicator also lights up on the display. Reception improves.



To restore the stereo effect, press FM MODE again so that “STEREO” appears on the display.

In this stereo mode, you can hear stereo sounds when a program is broadcast in stereo.

Presetting Stations

You can preset 30 FM and 15 AM stations.

In some cases, test frequencies have been already memorized for the tuner since the factory examined the tuner preset function before shipment. This is not a malfunction. You can preset the stations you want into memory by following the presetting method.

- There is a time limit in doing the following steps. If the setting is canceled before you finish, start from step 1 again.

On the unit ONLY:

1 Tune in the station you want to preset (in this example, of FM 87.50).

- See “Tuning in a Station.”

FM 87.50

2 Press SET.

SET



3 Press PRESET + or PRESET – to select a preset number.

P-01

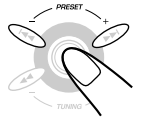

4 Press SET again.

STORED



The tuned station in step 1 is stored in the preset number selected in step 3.

- Storing a new station on a used number erases the previously stored one.



When you unplug the AC power cord or if a power failure occurs

The preset stations will be erased in a few days. If this happens, preset the stations again.

Tuning in a Preset Station

1 Press FM/AM.

The unit automatically turns on and tunes in the previously tuned station (either FM or AM).

- Each time you press the button, the band alternates between FM and AM.



2 Select a preset number.

On the unit:

Press PRESET + or PRESET –.

On the remote control:

Press the number buttons.

Ex.: For preset number 5, press 5.

For preset number 15, press +10 then 5.

For preset number 20, press +10, then 10.

For preset number 25, press +10, +10, then 5.

For preset number 30, press +10, +10, then 10.

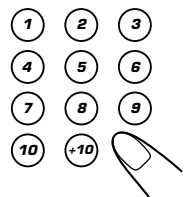
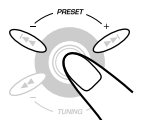

Playing Back CDs

Continued 

This unit has been designed to playback the following CDs: Audio CD, CD-R, and CD-RW.

When playing a CD-R or CD-RW

User-edited CD-Rs (CD-Recordable) and CD-RWs (CD-ReWritable) can be played back when they are already **“finalized.”**

- You can play back your original CD-Rs or CD-RWs recorded in music CD format **ONLY**. (If CD-RWs have been recorded in different format, erase all the data on CD-RWs completely before re-recording on the discs.)

 **DO NOT** play back CD-Rs or CD-RWs recorded the sound files such as MP3.

- Before playing back CD-Rs or CD-RWs, read their instructions or cautions carefully.
- Some CD-Rs or CD-RWs may not be played back on this unit because of their disc characteristics, damage or stain on them, or if the player’s lens is dirty.

Important notices:

- In general, you will have the best performance by keeping your CDs and the mechanism clean.
 - Store CDs in their cases, and keep them in cabinets or on shelves.
 - Keep the unit’s carrousel closed when not in use.
- Continuous use of irregular shaped discs (heart-shape, octagonal, etc.) can damage the disc rotating mechanism.

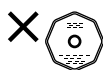
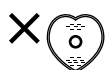

- CD-RWs may require a longer readout time since the reflectance of CD-RWs is lower than for regular CDs.

Loading CDs

1 Press .

The unit automatically turns on and the carrousel comes out.



2 Place one or two discs correctly on the front recesses of the disc tray, with its label side up.

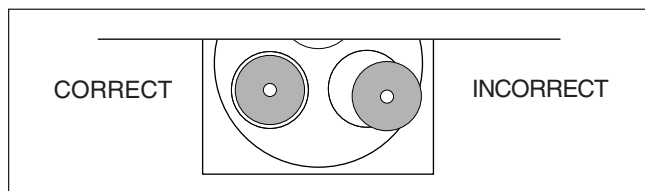

- When using a CD single (8 cm), place it on the inner recess of the disc tray.

3 If you wish to load a third disc, press **DISC CHANGE** on the unit or **DISC SKIP** on the remote control.

The disc tray rotates by 120°.



4 Press again.

The carrousel closes.



About the disc indicators

Each disc indicator corresponds to the disc tray of the same number.

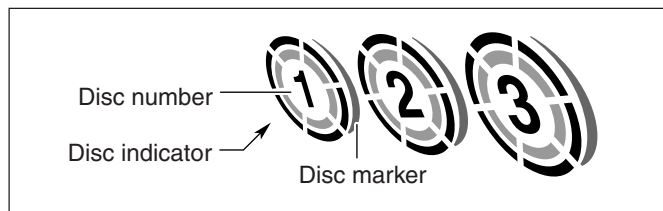



- The disc marker lights up for the disc number you have selected.
- The disc indicator rotates while the corresponding CD is being played.
- The disc indicator goes off when the unit has detected that there is no CD on the corresponding disc tray.

Playing Back CDs—All Disc and One Disc

You can play all loaded CDs continuously—All Disc play, or one selected disc—One Disc play.

All Disc play

1 Load CDs.

- If the current playing source is not the CD player, press CD , then  before going to the next step.

2 Press **REPEAT** repeatedly so that the **ALL DISC** indicator lights up on the display.



Track number of the currently playing disc flashes (Track numbers exceeding 16 are not displayed.)

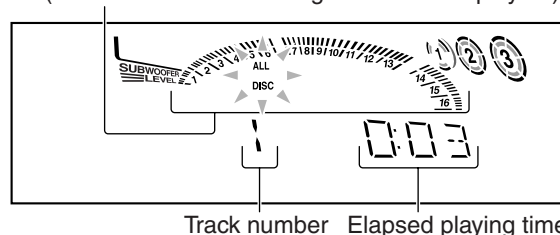

- Each time you press the button, the indication on the display changes as follows:



* See page 15.

3 Press one of the disc number buttons (CD1, CD2 or CD3) for the disc you want to start to play from.

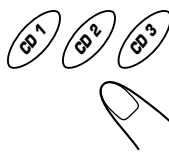

CD play starts from the first track of the selected disc.

- Pressing CD ►/|| instead of the disc number buttons starts playing back if a CD is on the trays.

To stop during play, press ■.

To remove the disc, press ▲.



CD playback sequence

When 3 CDs are loaded on the disc trays, they are played in one of the following sequences.

- When CD1 is pressed : CD1 ⇒ CD2 ⇒ CD3 (then stops)
- When CD2 is pressed : CD2 ⇒ CD3 ⇒ CD1 (then stops)
- When CD3 is pressed : CD3 ⇒ CD1 ⇒ CD2 (then stops)
- * When only 2 CDs are loaded, they are played in the same order, but the disc tray without a CD is skipped.

One Disc play

When 2 or 3 CDs are loaded on the disc trays, you can select one particular disc to be played back.

1 Load CDs.

- If the current playing source is not the CD player, press CD ►/||, then ■ before going to the next step.

2 Press REPEAT repeatedly so that the 1 DISC indicator lights up on the display.

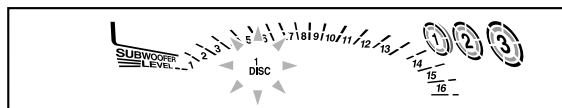
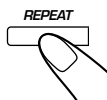

- Each time you press the button, the indication on the display changes as follows:

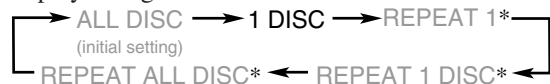

* See page 15.

3 Press one of the disc number buttons (CD1, CD2 or CD3) you want to listen.

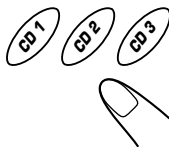

Playback stops when all tracks of the selected disc are played once and resumes to All Disc play.

To stop during play, press ■.

To remove the disc, press ▲.

To exit from One Disc Play, press REPEAT repeatedly so that ALL DISC indicator lights up on the display.



The following operations will also cancel the One Disc play and restore All Disc play when—

- Turning off the power,
- Ejecting the carrousel, or
- Changing the source to play.

Basic CD Operations

While playing a CD, you can do the following operations.

To exchange CDs during playback of another

Press DISC CHANGE to change the CD and the carrousel comes out.



If you change CDs during play, the current play will not stop until all CDs you have changed are played.

To close the carrousel, press DISC CHANGE or ▲.

To skip to the another CD in the carrousel

Press DISC SKIP on the remote control.



To stop play for a moment

Press CD ►/||.

While pausing, "PAUSE" appears on the display.

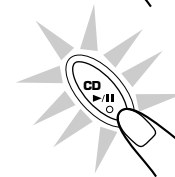

To resume play, press CD ►/|| again.

To locate a particular point in a track

During play, press and hold ◀◀ or ▶▶.

- ◀◀: Fast reverses the disc.
- ▶▶: Fast forwards the disc.

When using the remote control, press and hold ◀◀/◀◀ or ▶▶/▶▶.

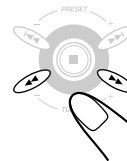

To go to another track

Press ◀◀ or ▶▶ repeatedly before or during playback.

- ◀◀: Goes back to the beginning of the current or previous tracks.
- ▶▶: Skips to the beginning of the next or succeeding tracks.

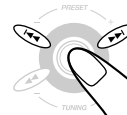

If you press and hold ◀◀ or ▶▶ on the unit before playing

The track number keeps changing until you release it.

To go to another track directly using the number buttons

Pressing the number button(s) before or during play allows you to start playing the track number you want.

- Ex.: For track number 5, press 5.
 For track number 15, press +10, then 5.
 For track number 20, press +10, then 10.
 For track number 32, press +10, +10, +10, then 2.

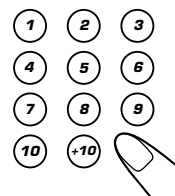

Programming the Playing Order of the Tracks —Program Play

You can arrange the order in which the tracks play before you start playing. **You can program up to 32 tracks.**

- To use Repeat play (see page 15) for Program play, press REPEAT after starting Program play.

On the unit ONLY:

1 Load CDs.

- If the current playing source is not the CD player, press CD ►/II, then ■ before going to the next step.

2 Press PROGRAM so that “PROGRAM” appears on the display.



The PRGM (program) indicator also lights up on the display.

- All Disc play mode is selected automatically. You cannot select One Disc play mode for Program play.

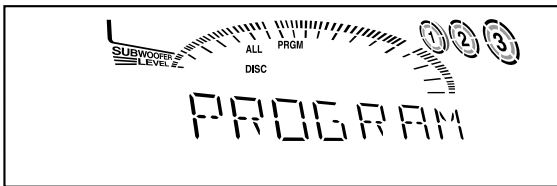

- If a program has been stored in memory, the program is called up.

3 Press one of the disc number buttons (CD1, CD2, and CD3) to select the disc number you want to play.

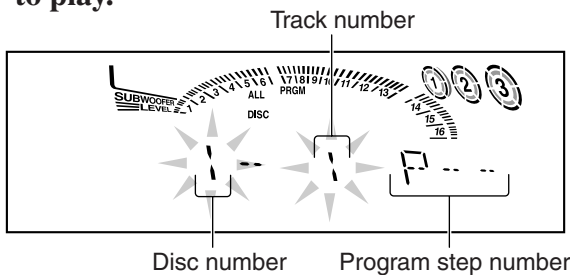
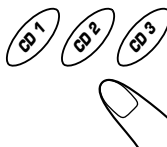

4 Press ◀◀ or ▶▶ to select the track number, then press SET.

Each time you select a track and press SET, the selected track number is added to the track number indicator.

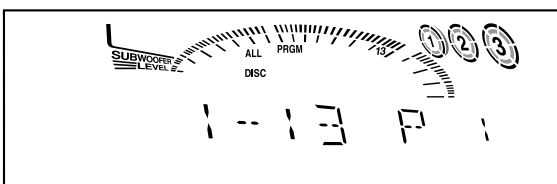
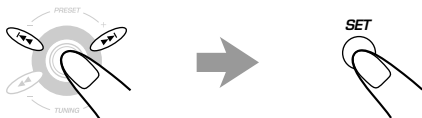

5 Program other tracks you want.

- To program tracks from the same disc, repeat step 4.
- To program tracks from a different disc, repeat steps 3 and 4.

6 Press CD ►/II.

The tracks are played in the order you have programmed.

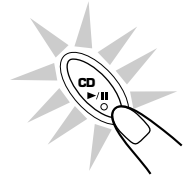

To stop during play, press ■.

To exit from Program play mode, press PROGRAM again before or after play so that the unit enters All Disc play mode. (The program you have made is stored in memory until you turn off the unit, eject the carrousel, or erase the program.)

- Program play mode is also canceled when you press ▲.

To modify the program

Before playing, you can erase the last programmed track shown on the display by pressing CANCEL/ DEMO.



- Each time you press the button, the last programmed track is erased from the program.

To check the program during play, press ▶▶ (or ◀◀) so that the playing track will change according to the program (or reverse) order.

To add tracks in the program before play, simply select the disc numbers and/or track numbers you want to add by following steps 3 and 4 of the programming procedure.

To erase the entire program before or during play, press ■ twice.

- Turning the power off or ejecting the carrousel will also erase the stored memory.



If you try to program a 33rd track “FULL” will appear on the display.



If your entry is ignored

You have tried to program a track from an empty tray, or a track number that does not exist on the CD. Such entries are ignored.



Playing at Random—Random Play

The tracks of the selected CD will play at random.

- To use Random play mode, you have to cancel the Program play mode.

1 Load a CD.

2 Press one of the disc number buttons (CD1, CD2, and CD3) for the disc you want to play, then press ■.

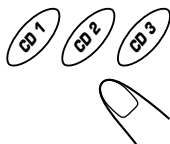

3 Press RANDOM so that “RANDOM” appears on the display.



The RANDOM indicator also lights up on the display.

- Activating Random play cancels Repeat play or All Disc play. (One Disc is automatically selected.)



- The tracks are played automatically at random. Random play ends when all tracks are played once.

To stop during play, press ■.

To exit from Random play mode, press RANDOM again during play so that the unit enters All Disc play mode.

- Random play is also canceled when you press ▲.



If you press ◀◀ or ▶▶

Skips to the next track selected randomly.

Repeating Tracks or CDs—Repeat Play

You can have all the CDs, the program or the individual track currently playing repeat as many times as you like.

- Repeat play and Random play cannot be used at the same time.

To repeat play, press REPEAT during or before playing.

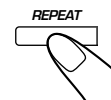

- Each time you press the button, Repeat play mode changes as follows, and the following indicator lights up on the display:

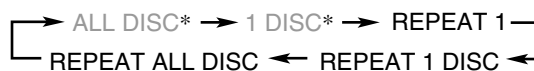

- REPEAT 1** : Repeats one track on one CD.
- REPEAT 1 DISC**** : Repeats all the tracks on one CD.
- REPEAT ALL DISC**: Repeats all the tracks on all the CDs, or all the tracks on the program.

* See pages 12 and 13.

** REPEAT 1 DISC is not used for Program play.

To cancel Repeat play, press REPEAT repeatedly until the REPEAT indicator (REPEAT 1, REPEAT 1 DISC or REPEAT ALL DISC) goes off from the display.

- Repeat play is also canceled when you press ▲.

Prohibiting Disc Ejection—Tray Lock

You can prohibit CD ejection from the unit and can lock the carrousel.

- This operation is possible only while the unit is on with CD selected as the source.

On the unit ONLY:

To prohibit disc ejection, press ▲ for the carrousel while holding ■.

“LOCKED” appears for a while, and the carrousel is locked.

To cancel the prohibition and unlock the carrousel, press ▲ for the carrousel while holding ■.

“UNLOCKED” appears for a while, and the carrousel is unlocked.



If you try to eject CDs

“LOCKED” appears to inform you that the Tray Lock is in use.

Playing Back Tapes



Playing Back a Tape

1 Press EJECT (▲) for the deck you want to use.

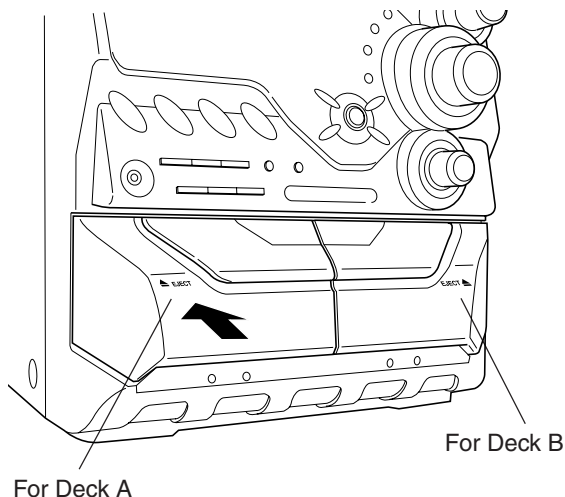

2 Put a cassette in, with the exposed part of the tape down and the side you want to play facing front.

- You can play back only type I tapes.

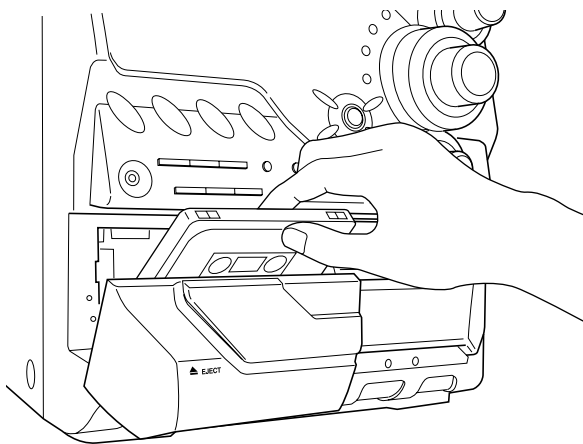

3 Close the cassette holder gently.

If you put cassettes in both decks A and B, the last deck which you have put a cassette into is selected.

To operate the other deck, press TAPE A or TAPE B (or TAPE A/B on the remote control).

4 Press TAPE ►.

The tape play starts and the tape running indicator (►) starts flashing slowly.

When the tape plays to the end, the deck automatically stops.



To stop during play, press ■.

To operate the other deck, press TAPE A or TAPE B (or TAPE A/B on the remote control), then TAPE ►.

To fast-forward the tape, press ►► (or ►►/►► on the remote control). The tape running indicator (►) starts flashing quickly.

To rewind the tape, press ◀◀ (or ◀◀/◀◀ on the remote control). The tape running indicator (◀) starts flashing quickly.

To remove the cassette, press ▲ EJECT for deck A or EJECT ▲ for deck B.

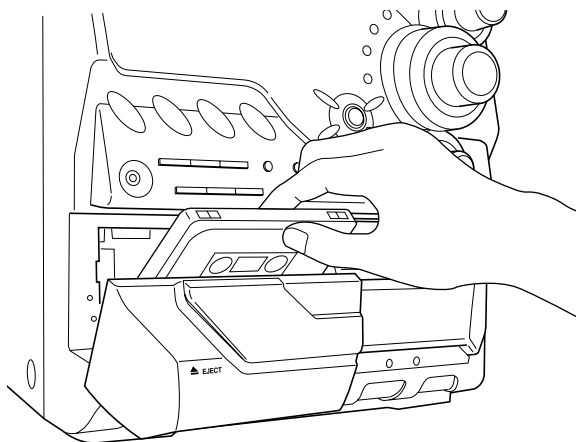
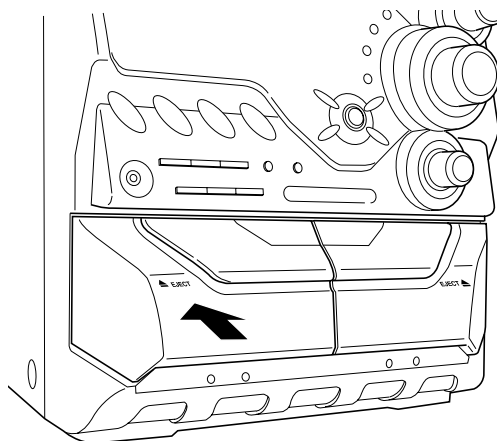

The use of the C-120 or thinner tape is not recommended, since characteristic deterioration may occur and this tape easily jams in the pinch-rollers and the capstans.

Recording

IMPORTANT:

- It should be noted that it may be unlawful to re-record pre-recorded tapes, records, or discs without the consent of the owner of copyright in the sound or video recording, broadcast or cable program and in any literary, dramatic, musical, or artistic embodied therein.
- The recording level is automatically set correctly, so it is not affected by the VOLUME, the SUBWOOFER LEVEL, and the SOUND MODE controls. Thus, during recording you can adjust the sound you are actually listening to without affecting the recording level.
- While recording, you can hear sound modes through the speakers or headphones. However, the sound is recorded without these effects (see page 10).
- If recordings you have made have excessive noise or static, the unit may be too close to a TV. Place the unit away from the TV.
- You can use type I tape for recording.

To protect your recording

Cassettes have two small tabs on the back to protect unexpected erasure or re-recording.

To protect your recording, remove these tabs.

To re-record on a protected tape, cover the holes with adhesive tape.

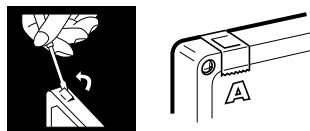

To keep the best recording and playback sound quality

If the heads, capstans, and pinch rollers of the cassette decks become dirty, the following will occur:

- Impaired sound quality
- Discontinuous sound
- Fading
- Incomplete erasure
- Difficulty in recording

To clean the head, capstan, and pinch roller

Use a cotton swab moistened with alcohol.

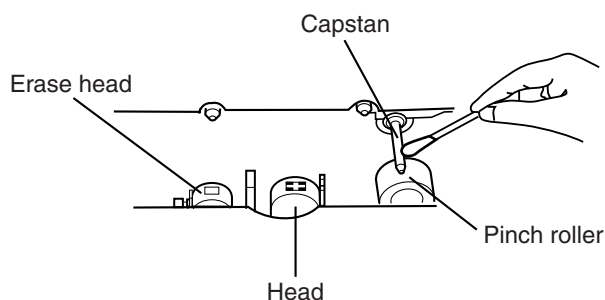

To demagnetize the head

Turn off the unit, and use a head demagnetizer (available at electronics and audio shops).

Recording a Tape on Deck B

On the unit ONLY:

1 Press EJECT ▲ for deck B.

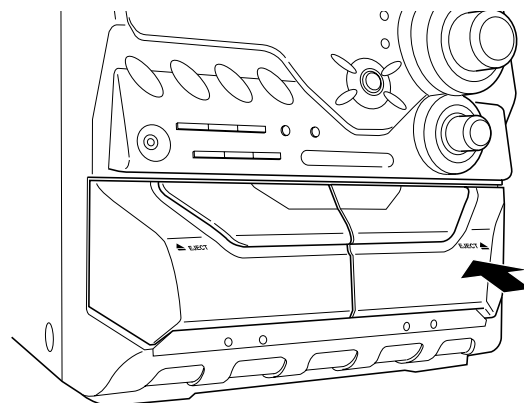

2 Put a recordable cassette in, with the exposed part of the tape down and the side you want to record facing front.

3 Close the cassette holder gently.

4 Start playing the source—FM, AM, CD player or auxiliary equipment connected to AUX IN jacks.

- For duplicating tapes, see “Dubbing Tapes” on page 18.
- For recording from CD, see “CD Synchronized Recording” on page 18.

5 Press REC START/STOP.

The REC (recording) indicator lights up on the display and recording starts.



To stop during recording, press REC START/STOP again or ■.

To remove the cassette, press EJECT ▲ for deck B.



Dubbing Tapes

On the unit ONLY:

1 Press **TAPE** , then .

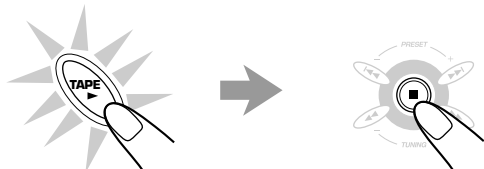



2 Put the source cassette in deck A, and a recordable cassette into deck B.

3 Press **DUBBING**.

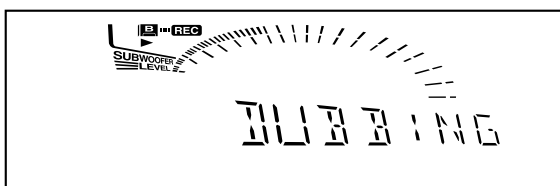
Dubbing starts.
“DUBBING” appears, and the REC (recording) indicator lights up on the display.



To stop during dubbing, press **REC START/STOP** or .

To remove the cassette, press  **EJECT** for deck A and **EJECT**  for deck B.

CD Synchronized Recording

You can easily record a CD onto a tape.

- You can also record the tracks in order you have made the program.

On the unit ONLY:

1 Put a recordable cassette into deck B.

2 Place a disc correctly on the recess of the disc tray, with its label side up.

3 Press one of the disc number buttons (**CD1**, **CD2**, and **CD3**) to select the disc, then .



4 Press **CD REC START**.

“CD REC” appears, and the REC (recording) indicator lights up on the display.

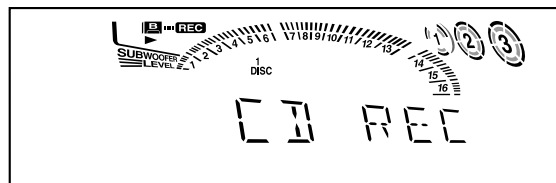
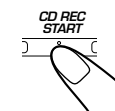

Deck B starts recording and the CD player starts playing.
When the recording is done, the CD player and deck B stop.

To stop during **CD Synchronized Recording**, press **REC START/STOP** or .

To remove the cassette, press **EJECT**  for deck B.

Using the Timers

There are three timers available—Daily Timer, Recording Timer, and Sleep Timer.

Before using the timers, you need to set the clock built in the unit. (See “Setting the Clock” on page 9.)

Using Daily Timer

With Daily Timer, you can wake to your favorite music or radio program. You can set the timer whether the unit is on or off.

How Daily Timer actually works

The unit automatically turns on, set the volume level to the preset level, and starts playing the specified source when the on-time comes (the ☺ indicator flashes while the timer is operating). Then, when the off-time comes, the unit automatically turns off (stands by).

Daily Timer works every day unless you cancel it.

- There is a time limit in doing the following steps. If the setting is canceled before you finish, start from step 1 again.
- If you have made a mistake while setting timer, press CANCEL/DEMO. (However, this does not always work. If CANCEL/DEMO does not work, press CLOCK/TIMER repeatedly and start from step 1 again.)

Before you start...

- *When using a CD as the source to play:*
—Make sure there is a CD on the currently selected disc number tray.
- *When using a tape as the source to play:*
—Make sure that a tape is in the deck whose deck indicator (A or B) is lit on the display.
- *When using the external component as the source to play:*
—Set the timer equipped with the external component at the same time.

On the unit ONLY:

1 Press CLOCK/TIMER repeatedly until “DAILY” appears on the display.

☺ indicator lights up and the DAILY (daily timer) indicator starts flashing on the display.

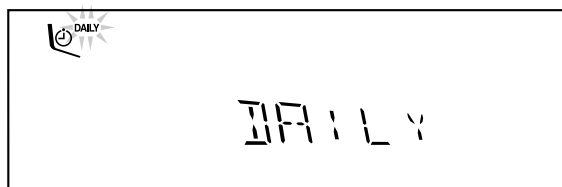

- Each time you press the button, the timer setting modes change as follows:

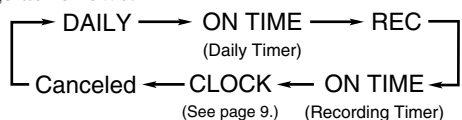

2 Press CLOCK/TIMER again.

“ON TIME” appears for 2 seconds, then the unit enters on-time setting mode.

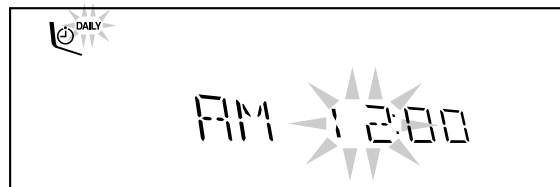

3 Set the on-time you want the unit to turn on.

- 1) Press ◀◀ or ▶▶ to set the hour, then press SET.
 - 2) Press ◀◀ or ▶▶ to set the minute, then press SET.
- “OFF TIME” appears for 2 seconds, then the unit enters off-time setting mode.

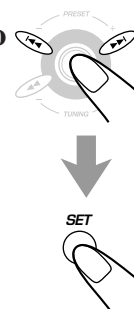

4 Set the off-time you want the unit to turn off (on standby).

- 1) Press ◀◀ or ▶▶ to set the hour, then press SET.
 - 2) Press ◀◀ or ▶▶ to set the minute, then press SET.
- The unit enters source selecting mode.

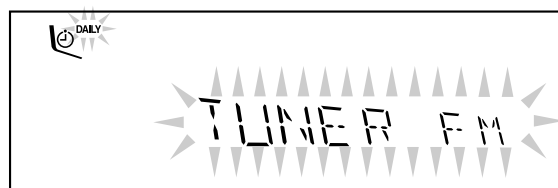
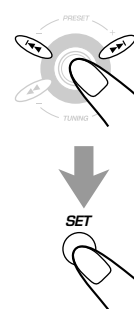

5 Press ◀◀ or ▶▶ to select the source to play, then press SET.

- Each time you press ◀◀ or ▶▶, the source changes as follows:

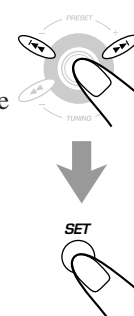

TUNER FM : tunes in to a specified preset FM station.

→ go to step 6.

TUNER AM : tunes in to a specified preset AM station.

→ go to step 6.

CD : plays a disc from the first track.

→ go to step 7.

TAPE : plays a tape in deck A or B.

→ go to step 7.

AUX : plays an external source.

→ go to step 7.

6 Select the preset station number.

Press **◀◀** or **▶▶** to select the preset station number, then press **SET**.
The unit enters volume setting mode.

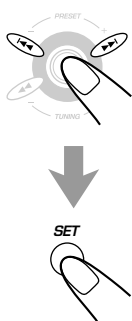

7 Press **◀◀** or **▶▶** to set the volume level.

You can select the volume level from **VOL MIN**, **VOL 1 — VOL 30**, and **VOL MAX**.

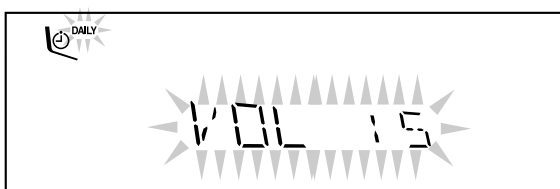
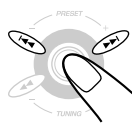

8 Press **SET** to complete the Daily Timer setting.

The **DAILY** (daily timer) indicator stops flashing and remains lit. The settings you have done are shown on the display in sequence for your confirmation.



9 Press **⏻/STANDBY/ON** to turn off the unit (on standby) if you have set the Daily Timer with the unit turned on.

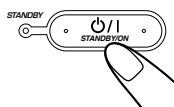

notes If the unit is turned on when the timer-on time comes Daily Timer does not work.

To turn on or off Daily Timer after its setting is done

1 Press **CLOCK/TIMER** repeatedly until **"DAILY"** appears on the display.



2 To turn off the Daily Timer, press **CANCEL/DEMO**.

The **DAILY** (daily timer) indicator goes off from the display ("**OFF**" appears for a while). The Daily Timer is canceled, but the setting for the Daily Timer remains in memory until you change it.



To turn on the Daily Timer, press **SET**.

The **DAILY** (daily timer) indicator lights up on the display. The settings you have done are shown on the display in sequence for your confirmation.



Using Recording Timer

With Recording Timer, you can make a tape of a radio broadcast automatically. You can set the timer whether the unit is on or off.

How Recording Timer actually works

The unit automatically turns on, tunes into the specified station, sets the volume level to "VOL MIN," and starts recording when the on-time comes (the indicator flashes while the timer is operating). Then, when the off-time comes, the unit automatically turns off (stands by).

Recording Timer works only once, but the timer setting remains in memory until you change it.

- There is a time limit in doing the following steps. If the setting is canceled before you finish, start from step 2 again.
- If you have made a mistake while setting the timer, press **CANCEL/DEMO**. (However, this does not always work. If **CANCEL/DEMO** does not work, press **CLOCK/TIMER** repeatedly and start from step 2 again.)

On the unit ONLY:

1 Put a recordable cassette into deck B.

2 Press **CLOCK/TIMER** repeatedly until **"REC"** appears on the display.

indicator lights up and the **REC** (recording timer) indicator starts flashing on the display.



- Each time you press the button, the timer setting modes change as follows:



3 Press **CLOCK/TIMER** again.

"ON TIME" appears for 2 seconds, then the unit enters on-time setting mode.





4 Set the on-time you want the unit to turn on.

- 1) Press ◀◀ or ▶▶ to set the hour, then press SET.
- 2) Press ◀◀ or ▶▶ to set the minute, then press SET.
“OFF TIME” appears for 2 seconds, then the unit enters off-time setting mode.

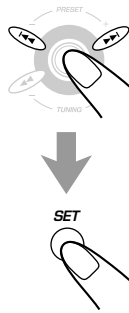

5 Set the off-time you want the unit to turn off (on standby).

- 1) Press ◀◀ or ▶▶ to set the hour, then press SET.
- 2) Press ◀◀ or ▶▶ to set the minute, then press SET.
The unit enters preset station selecting mode.

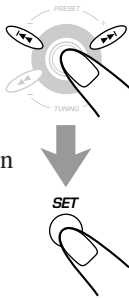

6 Select the preset station.

- 1) Press ◀◀ or ▶▶ to select the band (“TUNER FM” or “TUNER AM”), then press SET.
- 2) Press ◀◀ or ▶▶ to select a preset channel number, then press SET.
The REC (recording timer) indicator stops flashing and remains lit. The settings you have done are shown on the display in sequence for your confirmation.

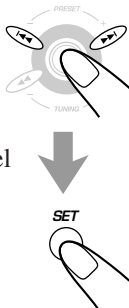

7 Press ⏻/STANDBY/ON to turn off the unit (on standby) if necessary.

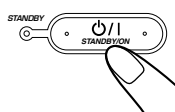

About the recording source

If you change the source while recording, the recording source also changes.

To turn on or off Recording Timer after its setting is done

- 1 Press CLOCK/TIMER repeatedly until “REC” appears on the display.



- 2 To turn off the Recording Timer, press CANCEL/DEMO.



The REC (recording timer) indicator goes off from the display (“OFF” appears for a while). The Recording Timer is canceled, but the setting for the Recording Timer remains in memory until you change it.

To turn on the Recording Timer, press SET.
The REC (recording timer) indicator lights up on the display. The settings you have done are shown on the display in sequence for your confirmation.



Using Sleep Timer

With Sleep Timer, you can fall asleep to music. You can set Sleep Timer when the unit is turned on.

How Sleep Timer actually works

The unit automatically turns off after the specified time length passes.

On the remote control ONLY:

1 Press SLEEP.

The time length until the shut-off time appears and the SLEEP indicator starts flashing on the display.

- Each time you press the button, the time length changes as follows:

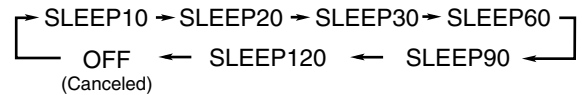

2 Wait for about 5 seconds after specifying the time length.

The SLEEP indicator stops flashing and remains lit.

To check the remaining time until the shut-off time, press SLEEP once so that the remaining time until the shut-off time appears for about 5 seconds.

To change the shut-off time, press SLEEP repeatedly until the desired time length appears on the display.

To cancel the setting, press SLEEP repeatedly until “OFF” appears on the display so that the SLEEP indicator goes off from the display.

- Sleep Timer is also canceled when you turn off the unit.

Timer Priority

Since each timer can be set separately, you may wonder what happens if the setting for these timers overlaps. Here are some examples.

Here are some examples.

- **Recording Timer has priority over Daily Timer.**

If Recording Timer is set to come on while Daily Timer is operating, Daily Timer is canceled and Recording Timer start working.

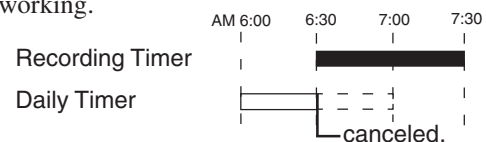

- If Sleep Timer overlaps with another timer (either Daily Timer or Recording Timer), a timer with the earlier shut-off time has priority.

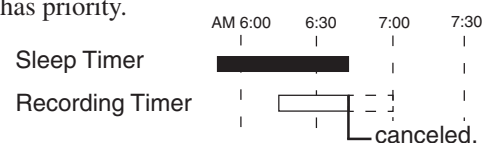

When using the Recording Timer and Sleep Timer at the same time, pay special attention to the shut-off time.

Maintenance



To get the best performance of the unit, keep your discs, tapes, and mechanism clean.

Cleaning the unit

• Stains on the unit

Should be wiped off with a soft cloth. If the unit is heavily stained, wipe it with a cloth soaked in water-diluted neutral detergent and wrung well, then wipe clean with a dry cloth.

• Avoid the following since they may cause damage to the unit.

- DO NOT wipe it with a hard cloth.
- DO NOT wipe it strong.
- DO NOT wipe it with thinner or benzine.
- DO NOT apply any volatile substance such as insecticides to it.
- DO NOT allow any rubber or plastic to remain in contact with it for a long time.

Handling discs



- Remove the disc from its case by holding it at the edge while pressing the center hole lightly.
- Do not touch the shiny surface of the disc, or bend the disc.
- Put the disc back in its case after use to prevent warping.

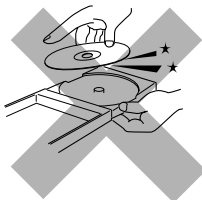

- Be careful not to scratch the surface of the disc when placing it back in its case.
- Avoid exposure to direct sunlight, temperature extremes, and moisture.



To clean the disc

Wipe the disc with a soft cloth in a straight line from center to edge.



DO NOT use any solvent—such as conventional record cleaner, spray, thinner, or benzine—to clean the disc.

Handling cassette tapes

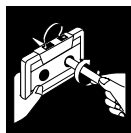

- If the tape is loose in its cassette, take up the slack by inserting a pencil in one of the reels and rotating.
- If the tape is loose, it may get stretched, cut, or caught in the cassette.



- Be careful not to touch the tape surface.



- Avoid the following places to store the tape:

- In dusty places
- In direct sunlight or heat
- In moist areas
- Near a magnet

Troubleshooting



If you are having a problem with your unit, check this list for a possible solution before calling for service.

If you cannot solve the problem from the hints given here, or the unit has been physically damaged, call a qualified person, such as your dealer, for service.

Symptom	Cause	Action
Unable to cancel the display demonstration.	Other buttons are pressed to cancel the display demonstration.	Press CANCEL/DEMO on the unit. (See page 8.)
No sound is heard.	Connections are incorrect or loose.	Check all connections and make corrections. (See pages 6 to 8.)
Hard to listen to broadcasts because of noise.	<ul style="list-style-type: none"> Antennas are disconnected. The AM loop antenna is too close to the unit. The FM antenna is not properly extended and positioned. 	<ul style="list-style-type: none"> Reconnect the antennas correctly and securely. Change the position and direction of the AM loop antenna. Extend the FM antenna at the best position.
The disc sound is discontinuous.	The disc is scratched or dirty.	Clean or replace the disc. (See page 22.)
The carrousel does not open or close.	<ul style="list-style-type: none"> The AC power cord is not plugged in. The carrousel is locked. 	<ul style="list-style-type: none"> Plug the AC power cord. Unlock the carrousel. (See page 15.)
The disc does not play.	The disc is placed upside down.	Place the disc with the label side up.
The cassette holders cannot be opened.	Power supply from the AC power cord has been cut off while the tape was running.	Turn on the unit.
Impossible to record.	Small tabs on the back of the cassette are removed.	Cover the holes with adhesive tape.
Operations are disabled.	The built-in microprocessor may malfunction due to external electrical interference.	Unplug the AC power cord and then plug it back in.
Unable to operate the unit from the remote control.	<ul style="list-style-type: none"> The path between the remote control and the remote sensor on the unit is blocked. The batteries are exhausted. 	<ul style="list-style-type: none"> Remove the obstruction. Replace the batteries.

Specifications

Design and specifications are subject to change without notice.

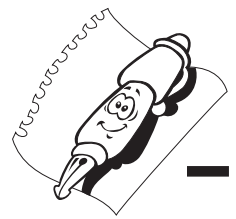

Amplifier section—CA-MXGT700

Output Power

SUBWOOFERS : 110 W per channel, min. RMS, driven into 6 Ω at 63 Hz with no more than 10% total harmonic distortion.

MAIN SPEAKERS: 55 W per channel, min. RMS, driven into 4 Ω at 1 kHz with no more than 10% total harmonic distortion.

Audio input sensitivity/Impedance

(at 1 kHz, measured at MAIN SPEAKERS)

AUX : 400 mV/50 kΩ

Digital output: DIGITAL OUT (OPTICAL)

Signal wave length : 660 nm

Output level : -21 dBm to -15 dBm

Speakers/Impedance : Subwoofers : 6 Ω – 16 Ω
Main speakers : 4 Ω – 8 Ω

Tuner

FM tuning range : 87.50 MHz – 108.00 MHz

AM tuning range : 530 kHz – 1 710 kHz

CD player

CD Capacity : 3 CDs

Dynamic range : 85 dB

Signal-to-noise ratio : 85 dB

Cassette deck

Frequency response

Normal (type I): 50 Hz — 14 000 Hz

Wow and flutter : 0.15% (WRMS)

General

Power requirement : AC 120 V[~], 60 Hz

Power consumption : 145 W / 200 VA (at operation)
19 W (on standby)

Dimensions (approx.): 270 mm x 317 mm x 449 mm (W/H/D)
(10^{11/16} in. x 12^{1/2} in. x 17^{11/16} in.)

Mass (approx.) : 9.1 kg (20.1 lbs)

Supplied accessories

See page 6.

Speaker section—SP-MXGT700

Type : 3-way bass-reflex type

Speaker units : Subwoofer : 20 cm (7^{7/8} in.) cone x1
Main Woofer : 9 cm (3^{8/16} in.) cone x1
Tweeter : 5 cm (2 in.) cone x1

Power handling capacity : Subwoofer : 110 W
Main speaker : 55 W

Impedance : Subwoofer : 6 Ω
Main speaker : 4 Ω

Frequency range : Subwoofer : 30 Hz — 95 Hz
Main speaker : 95 Hz — 20 000 Hz

Sound pressure level : Subwoofer : 81 dB/W•m
Main speaker : 82 dB/W•m

Dimensions (approx.) : 240 mm x 425 mm x 333 mm (W/H/D)
(9^{1/2} in. x 16^{3/4} in. x 13^{1/8} in.)

Mass (approx.) : 5.4 kg (12.0 lbs) each

Amplifier section—CA-MXG500

Output Power

SUBWOOFERS : 80 W per channel, min. RMS, driven into 6 Ω at 63 Hz with no more than 10% total harmonic distortion.

MAIN SPEAKERS: 40 W per channel, min. RMS, driven into 4 Ω at 1 kHz with no more than 10% total harmonic distortion.

Audio input sensitivity/Impedance

(at 1 kHz, measured at MAIN SPEAKERS)

AUX : 400 mV/50 kΩ

Digital output: DIGITAL OUT (OPTICAL)

Signal wave length : 660 nm

Output level : -21 dBm to -15 dBm

Speakers/Impedance : Subwoofers : 6 Ω – 16 Ω
Main speakers : 4 Ω – 8 Ω

Tuner

FM tuning range : 87.50 MHz – 108.00 MHz

AM tuning range : 530 kHz – 1 710 kHz

CD player

CD Capacity : 3 CDs

Dynamic range : 85 dB

Signal-to-noise ratio : 85 dB

Cassette deck

Frequency response

Normal (type I): 50 Hz — 14 000 Hz

Wow and flutter : 0.15% (WRMS)

General

Power requirement : AC 120 V[~], 60 Hz

Power consumption : 130 W / 200 VA (at operation)
17 W (on standby)

Dimensions (approx.): 270 mm x 317 mm x 449 mm (W/H/D)
(10^{11/16} in. x 12^{1/2} in. x 17^{11/16} in.)

Mass (approx.) : 8.8 kg (19.4 lbs)

Supplied accessories

See page 6.

Speaker section—SP-MXG500

Type : 3-way bass-reflex type

Speaker units : Subwoofer : 13.5 cm (5^{3/8} in.) cone x1
Main Woofer : 13.5 cm (5^{3/8} in.) cone x1
Tweeter : 5 cm (2 in.) cone x1

Power handling capacity : Subwoofer : 80 W
Main speaker : 40 W

Impedance : Subwoofer : 6 Ω
Main speaker: 4 Ω

Frequency range : Subwoofer : 32 Hz — 87 Hz
Main speaker : 87 Hz — 20 000 Hz

Sound pressure level : Subwoofer : 84 dB/W•m
Main speaker : 82 dB/W•m

Dimensions (approx.) : 282 mm x 318 mm x 322 mm (W/H/D)
(11^{1/8} in. x 12^{9/16} in. x 12^{11/16} in.)

Mass (approx.) : 5.0 kg (11.1 lbs) each

